

# Let's Fly Away

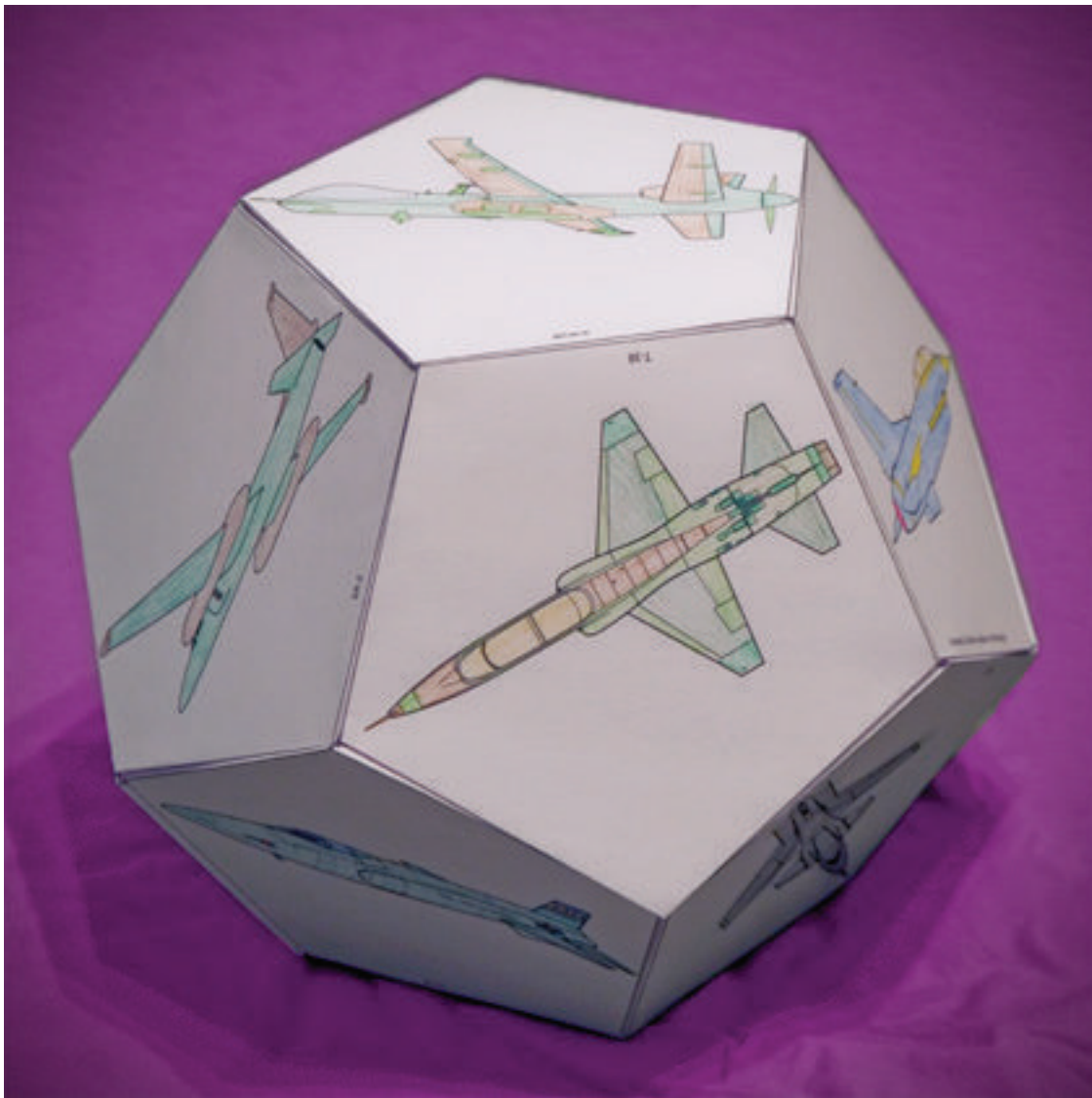

Color and Learn

A dodecahedron (doe decka hee drun) is a shape with 12 faces. It looks like a ball. Each face on this dodecahedron has a picture of a NASA aircraft.

After making the dodecahedron, you can hang it in your room.

### What Is Needed

- 12 aircraft patterns
- Crayons, markers or colored pencils
- Glue
- Scissors
- Tape
- Yarn or string

### How to Make the Dodecahedron

1. Color the 12 aircraft.
2. Cut out each circle.



3. Fold each pattern along the dotted lines. Fold toward the back to make small flaps. The five-sided shape is called a pentagon.



4. Use this step if you want to hang the dodecahedron. Tape a piece of string to the inside corner of one of the pentagons. Leave about 3 inches inside the pentagon. Make sure the string is long enough to hang the dodecahedron from the ceiling.



5. Divide the 12 pentagons into two groups of six each. Work with six pentagons at a time.

6. Use one pentagon for the center. Glue a flap from the five other pentagons on each of the flaps of the center pentagon.



7. Glue the side flaps of each pentagon to the side flap of the one next to it. This makes a bowl shape.



8. Repeat these steps with the other group of six pentagons.
9. There should now be two bowl shapes.



10. Glue the flaps of the bowl shapes together to make a dodecahedron. Be sure to pull the string to the outside before connecting all the flaps. You may need an adult's help.

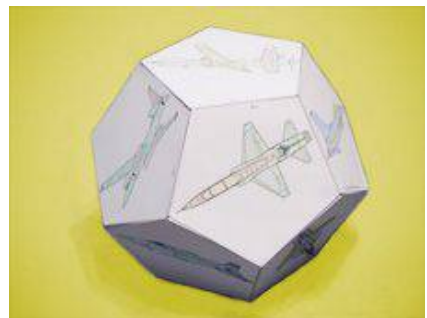

Play Let's Fly Away on NASA Kids' Club.

[http://www.nasa.gov/audience/forkids/kidsclub/flash/clubhouse/Lets\\_Fly\\_Away.html](http://www.nasa.gov/audience/forkids/kidsclub/flash/clubhouse/Lets_Fly_Away.html)

# X-48B Blended Wing Body

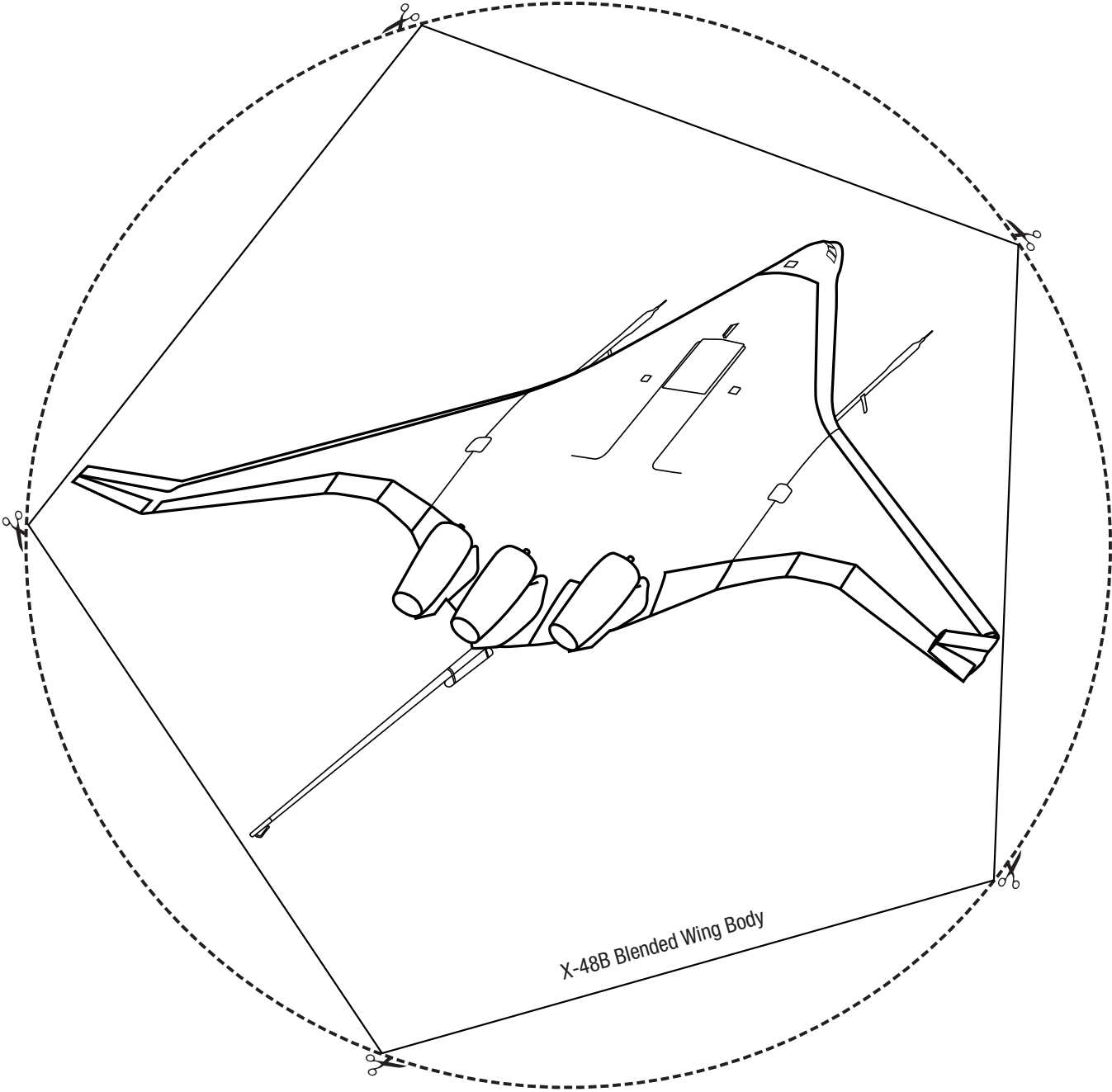

The Boeing Blended Wing Body gets its name from its triangle shape. It does not have a raised tail like most airplanes. Most airplanes are shaped like tubes with wings and a raised tail.

## T-38

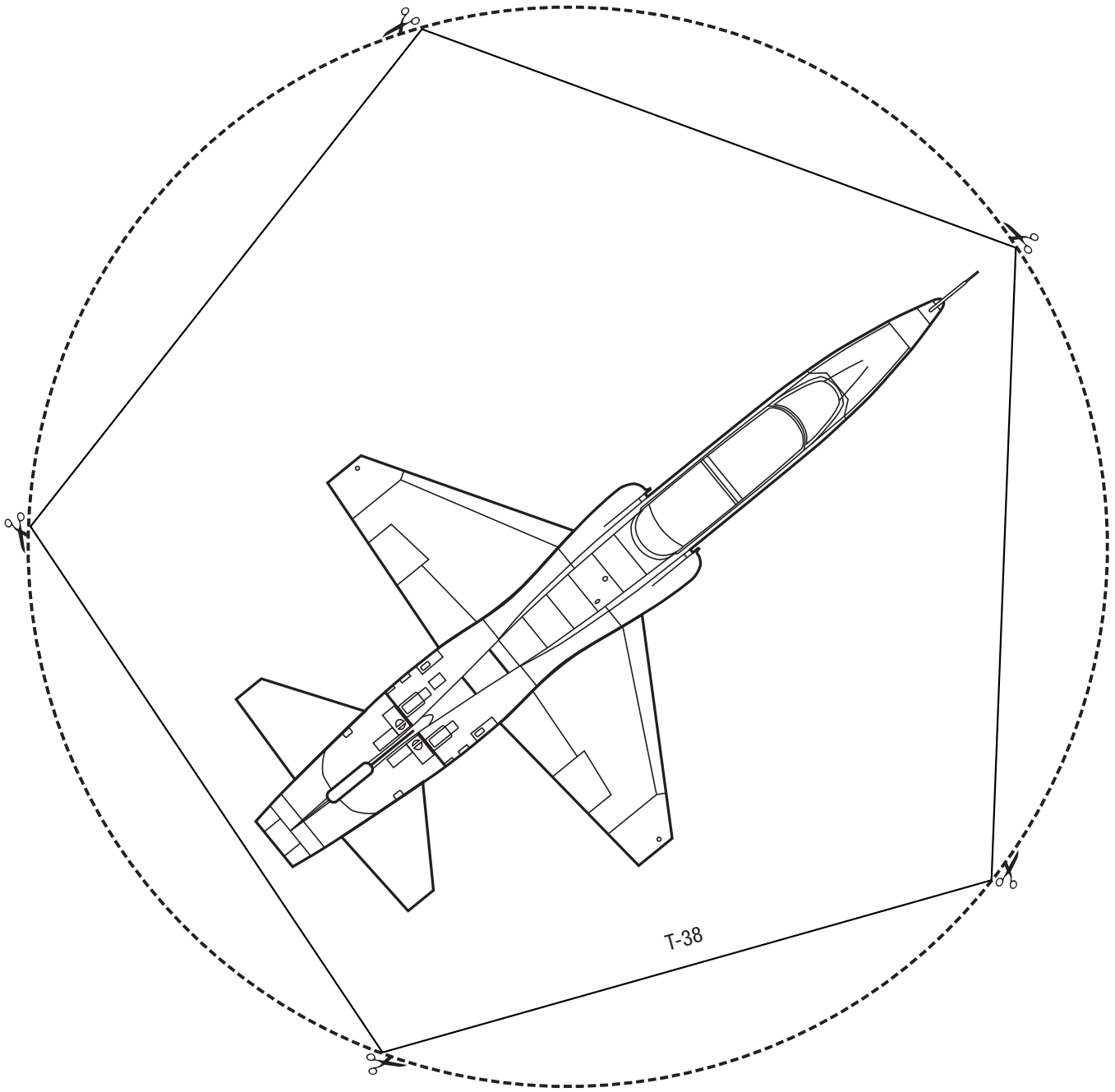

NASA uses T-38s for many tasks. They are often used as chase planes. Chase planes fly beside other aircraft during test flights. The airplane's crew watches for problems with the test aircraft. Photographers can ride along and take pictures of the flight.

# SOFIA

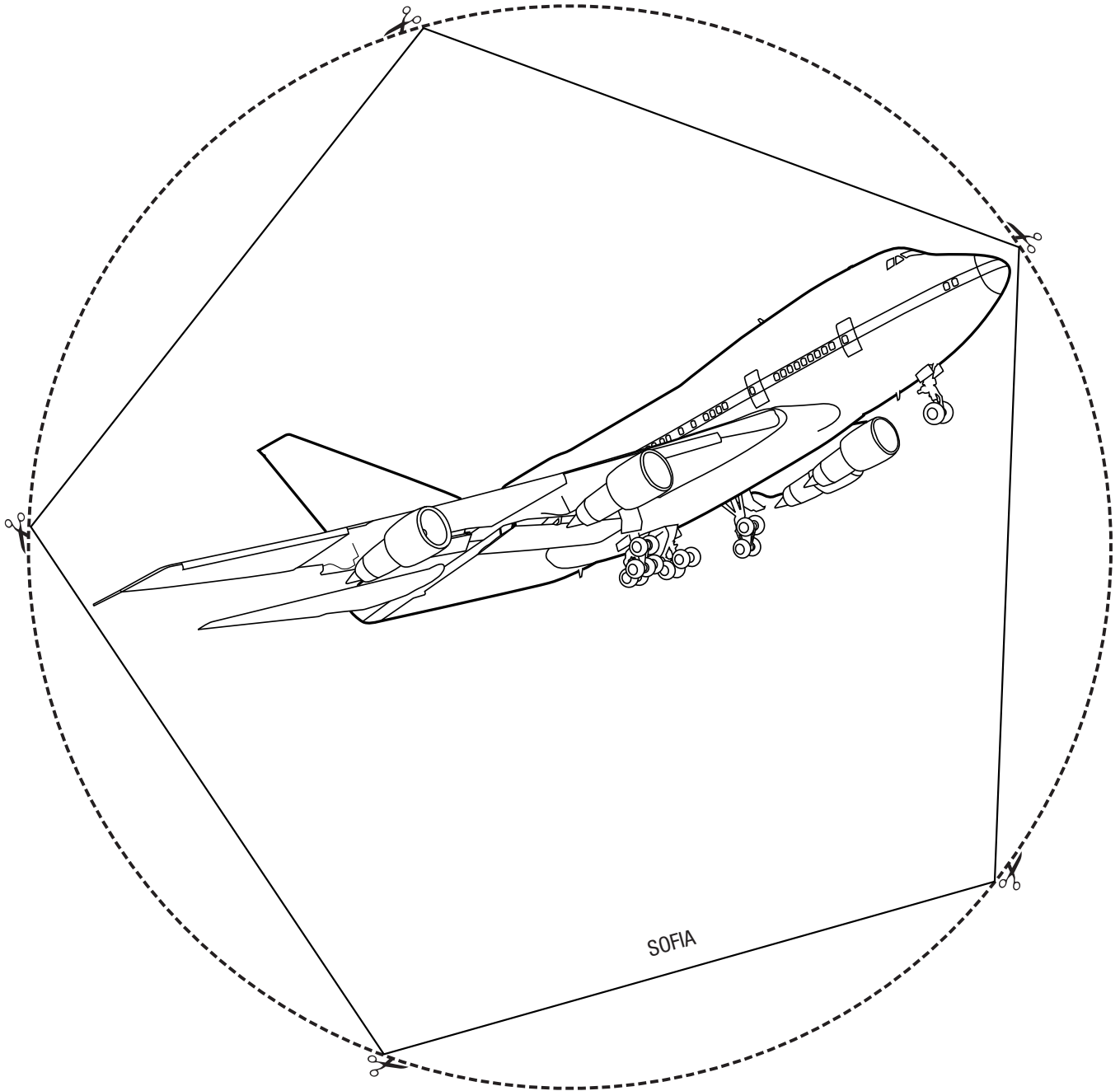

SOFIA is short for Stratospheric Observatory for Infrared Astronomy. This airplane is a Boeing 747SP that used to carry passengers. NASA changed it to carry a large telescope. Part of the SOFIA program lets teachers from across the United States do astronomy experiments on the airplane as it flies.

## F-15B Active

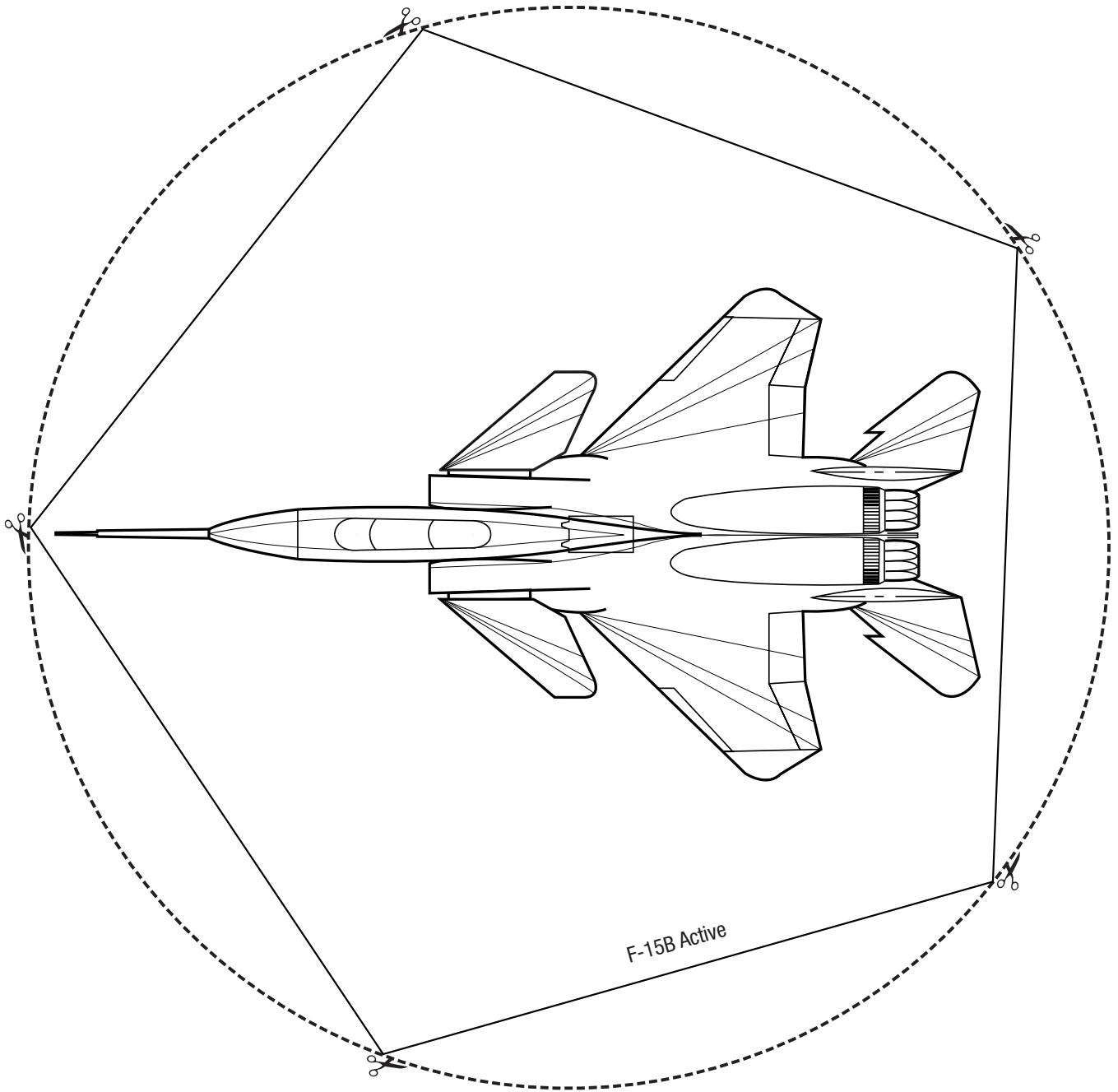

NASA used the F-15B Active to test technologies that could make other airplanes safer to fly.

## ER-2

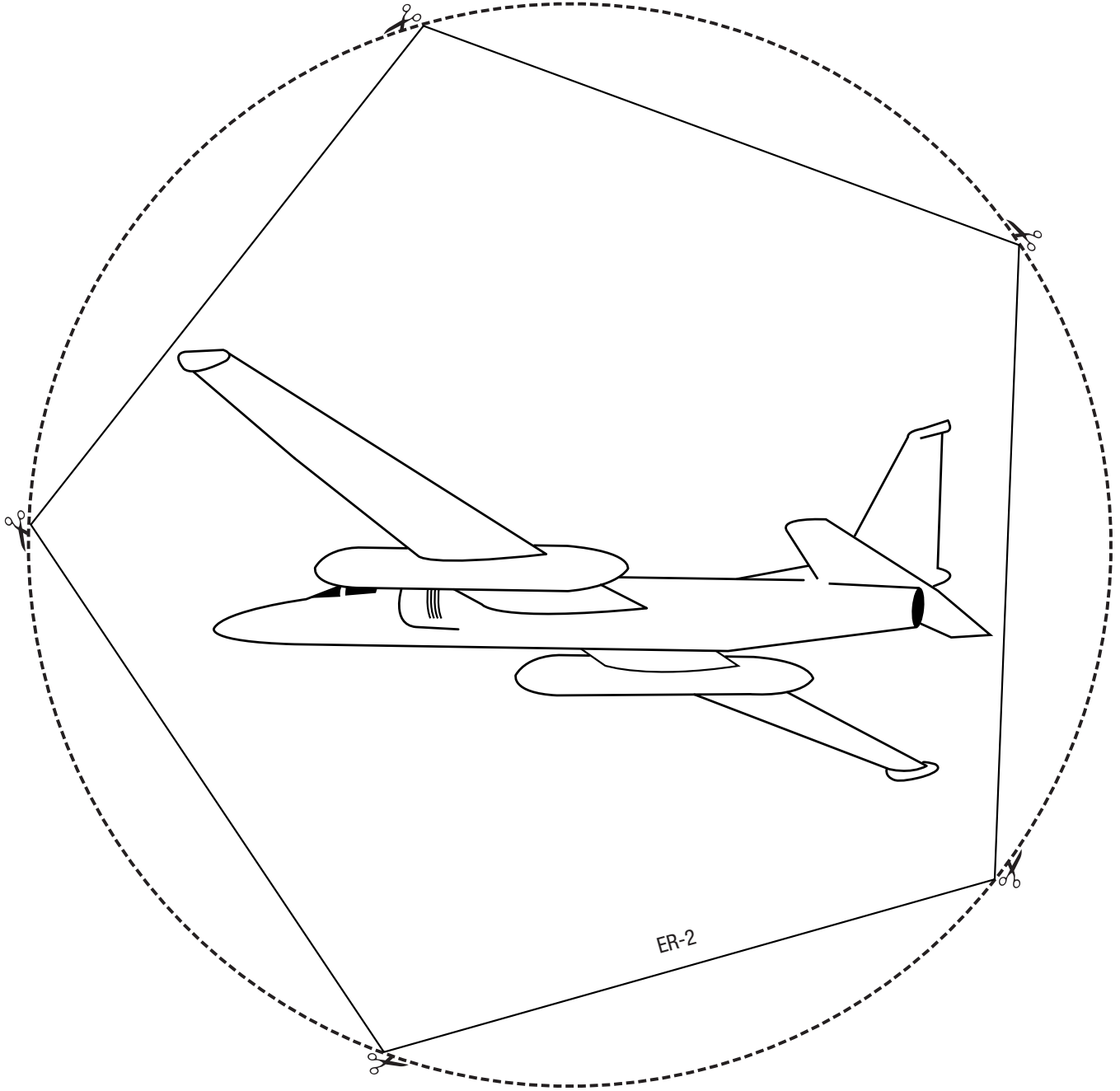

The ER-2 can fly to the edge of space. It carries many cameras that take pictures to help scientists study Earth. The cameras can take pictures of forest fires, changing weather and even erupting volcanoes.

## X-29

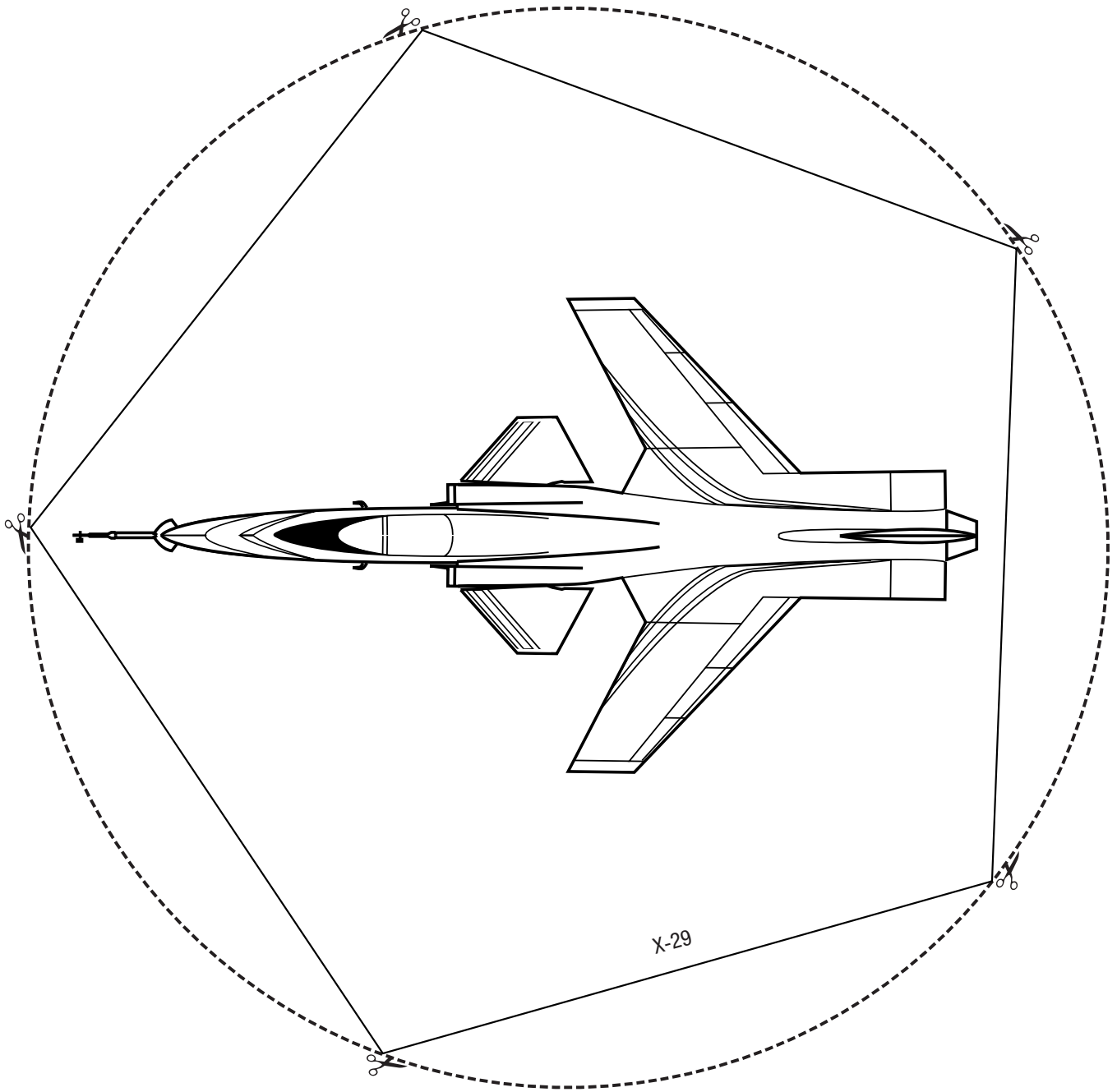

The X-29 almost looks as if it is flying backward. The forward-swept wings are fastened to the back of the aircraft. Stabilizers, which help keep an airplane flying straight, are in front of the wings instead of on the tail.

# Ikhana

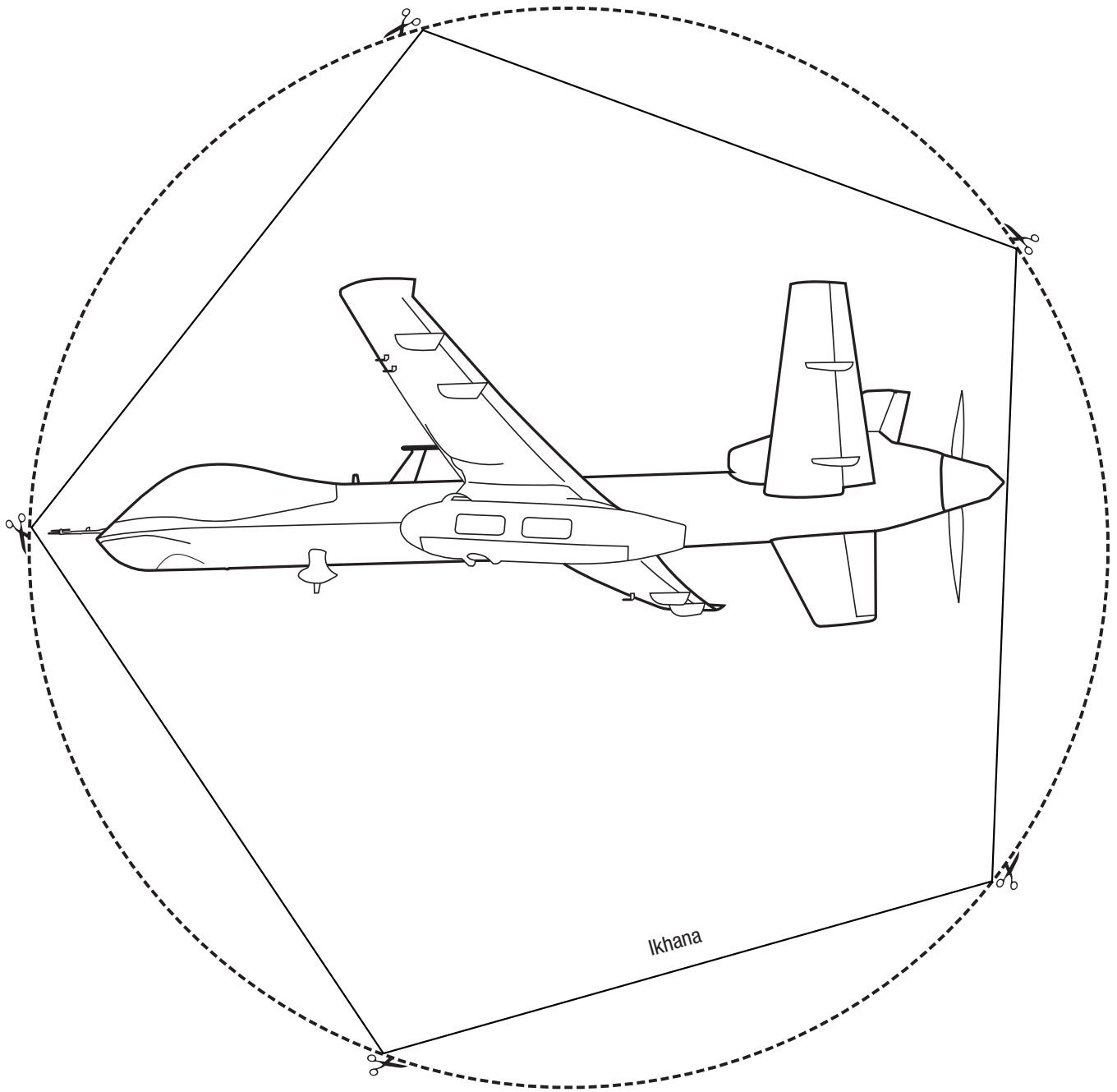

“Ikhana” is a Choctaw Nation name. It means “intelligent.” Ikhana is a remote-controlled airplane. It collects information to help scientists better understand Earth’s climate.

## SR-71 Blackbird

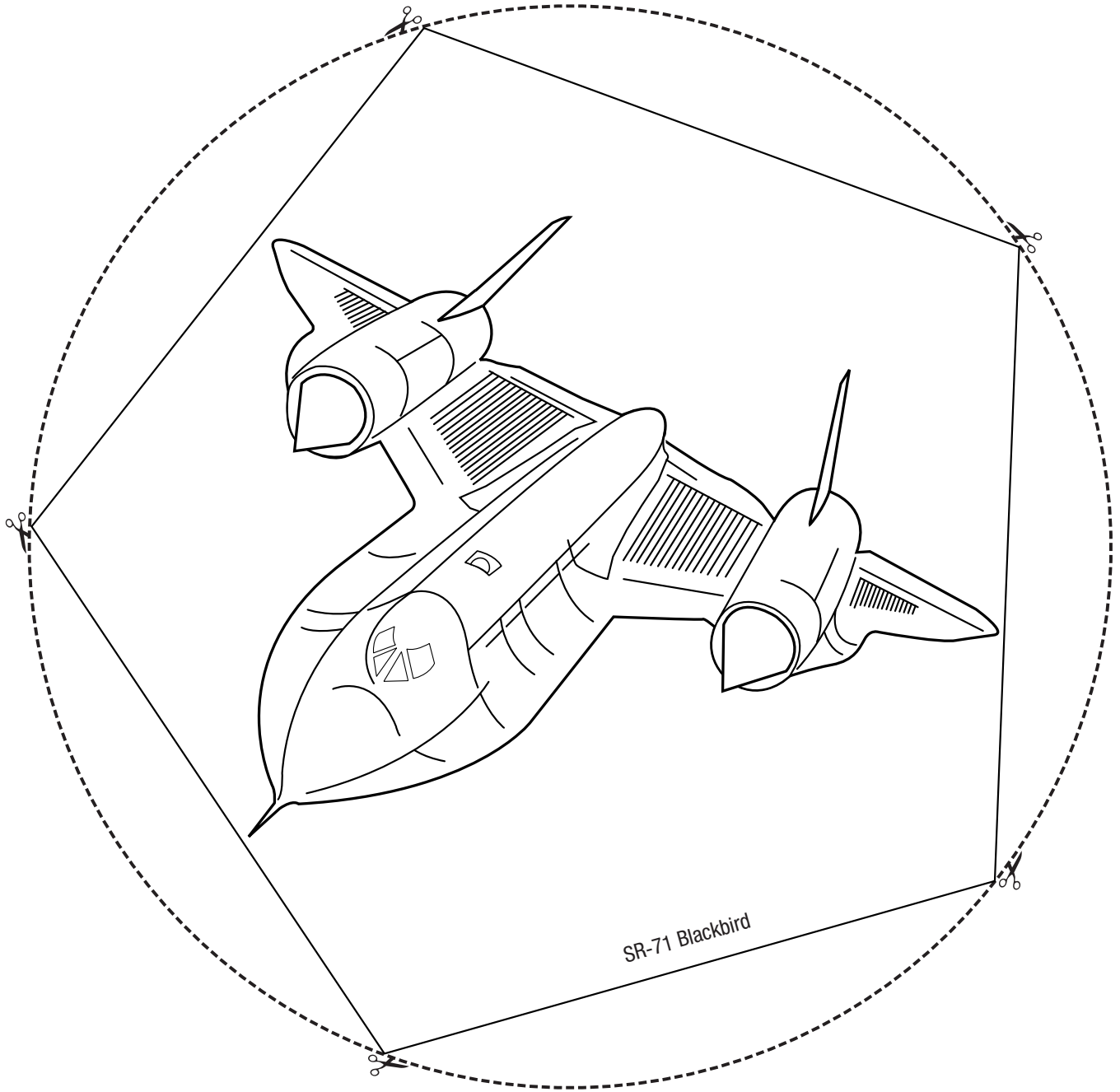

NASA used two SR-71 Blackbirds to test high-speed and high-altitude flying. The U.S. Air Force loaned them to NASA. The Blackbird can fly more than 2,200 miles per hour and up to 85,000 feet high.

## X-1

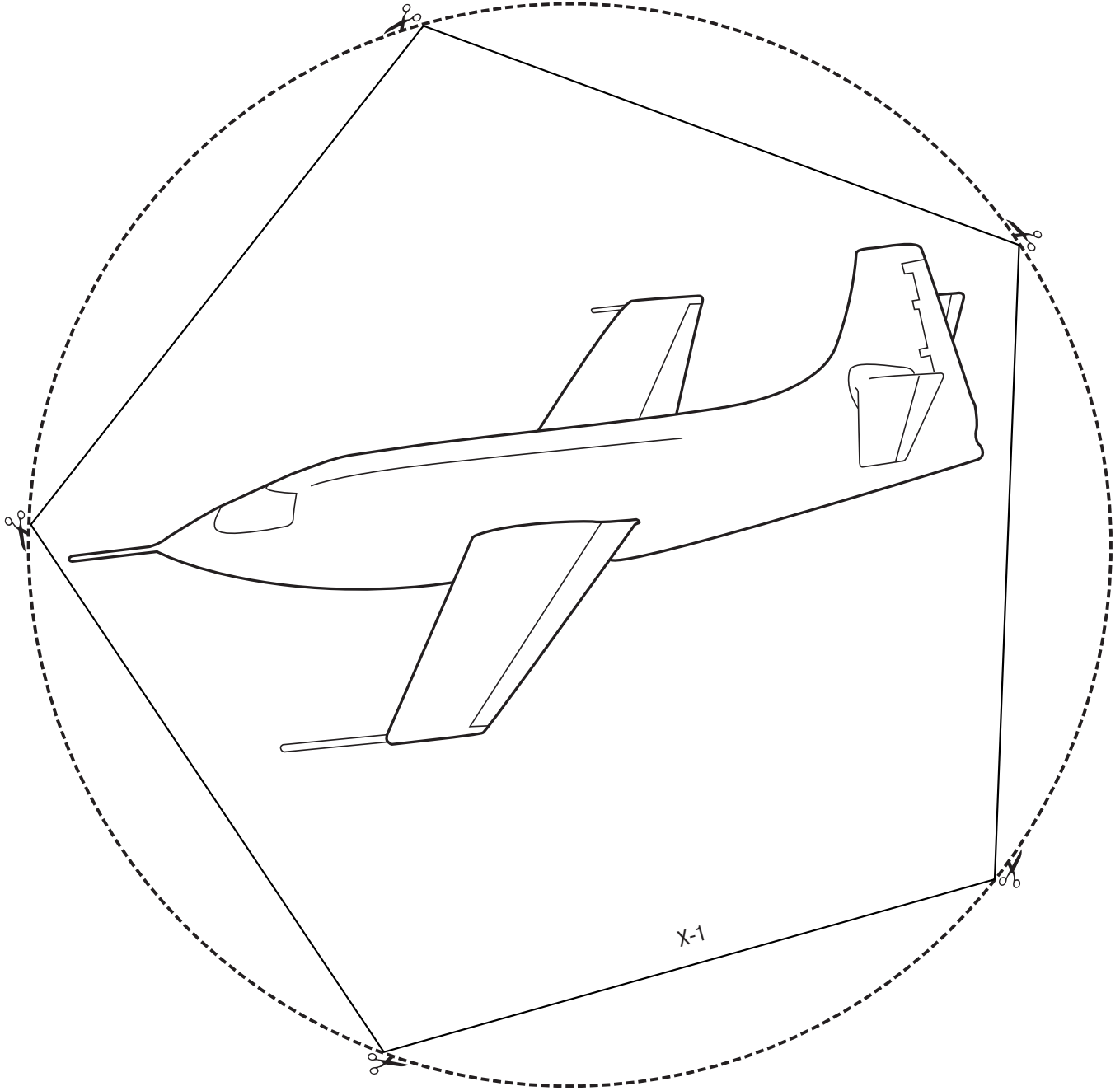

The X-1 program was first called the XS-1 for “Experimental Sonic.” The X-1 program proved that humans could fly faster than the speed of sound.

## Automatic Collision Avoidance Technology

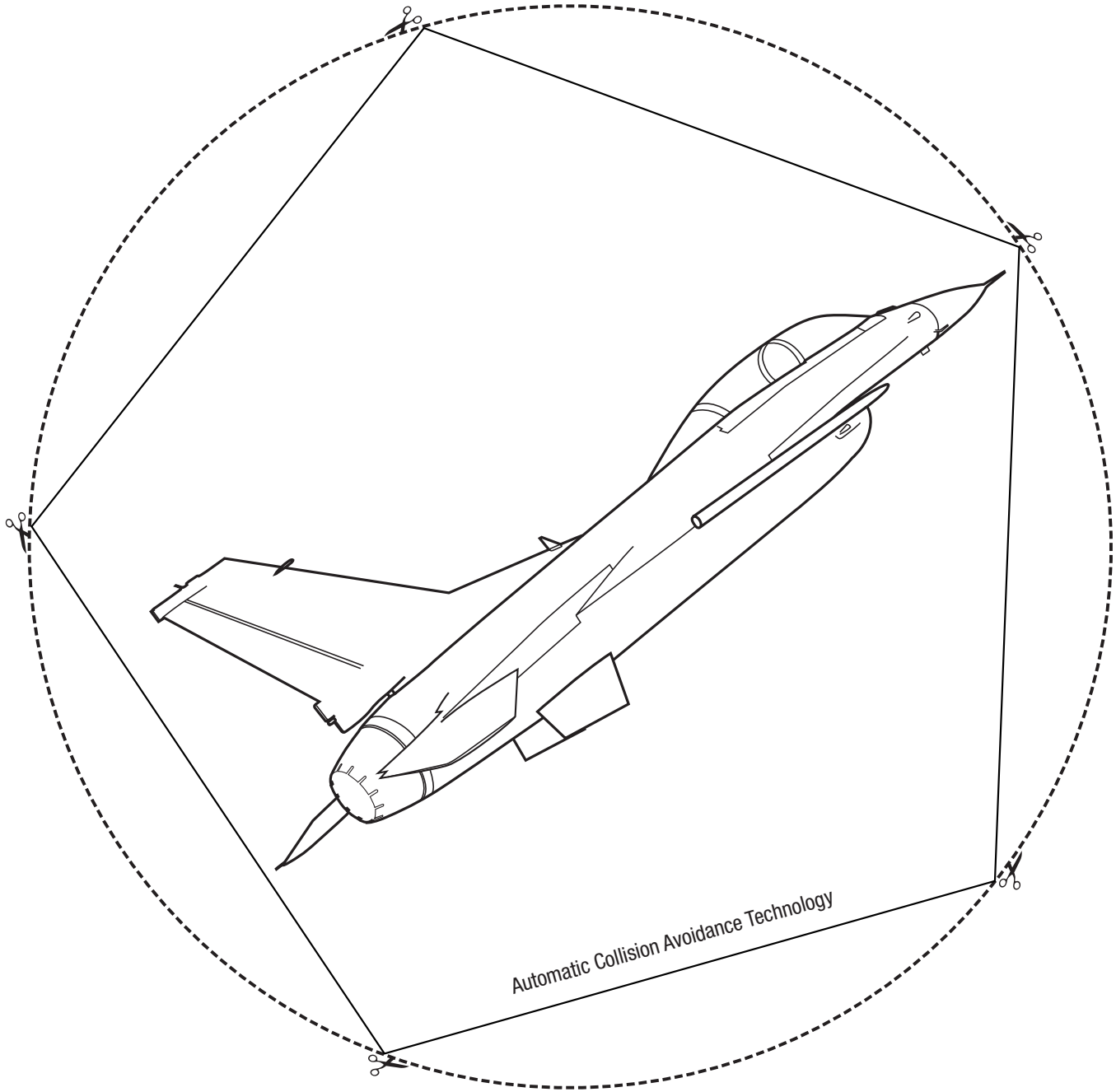

NASA's Dryden Flight Research Center in California is working with the U.S. Air Force on this project. Computer systems put on board will help keep high-speed fighter aircraft from crashing into each other.

## X-43A Hypersonic Experimental Vehicle

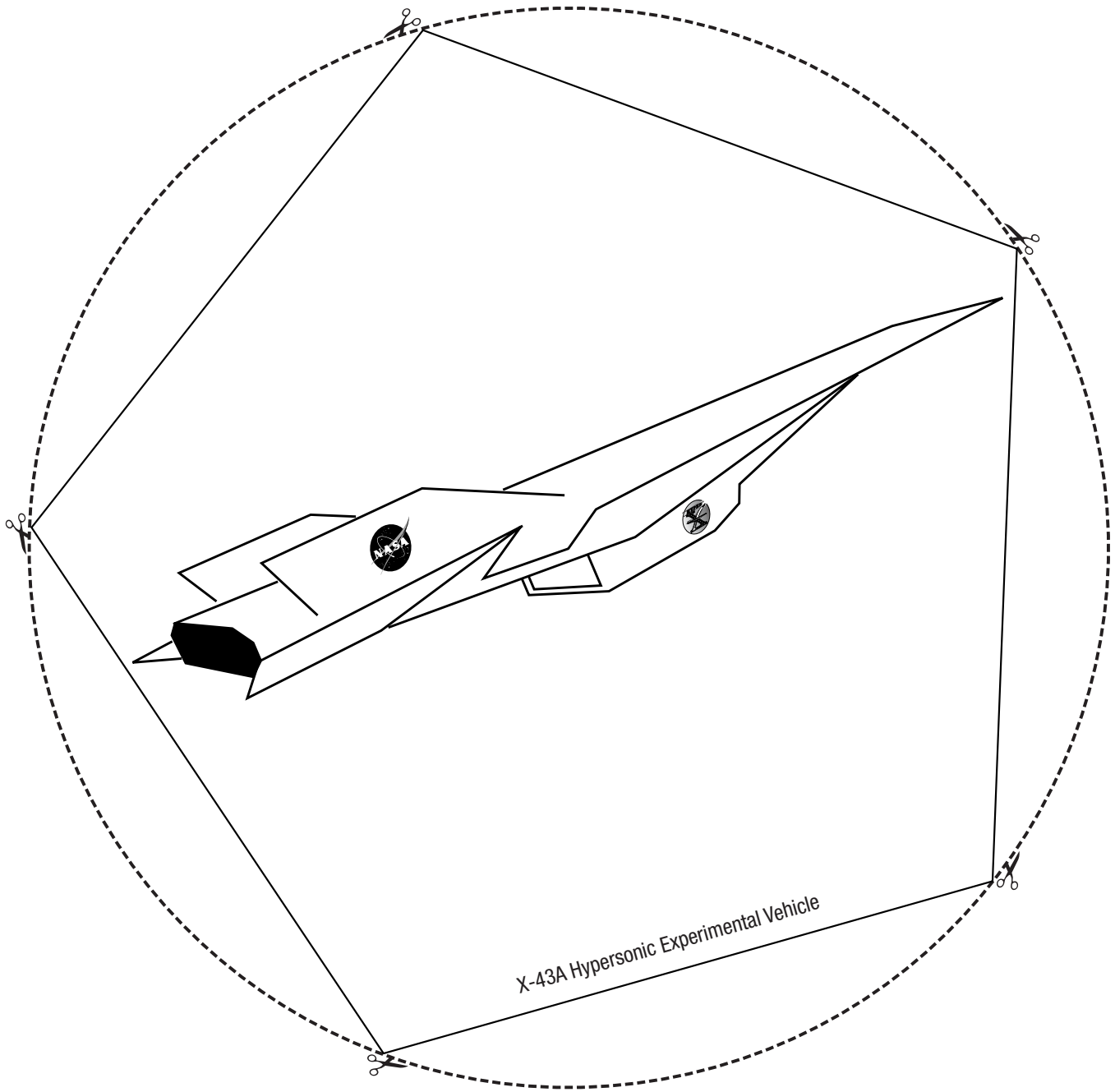

NASA's X-43A hypersonic research aircraft is remote-controlled. It was the first scramjet-powered aircraft to fly five times the speed of sound. The flight took place on Nov. 16, 2004, and reached a speed of Mach 9.6, or almost 7,000 mph.

## X-15

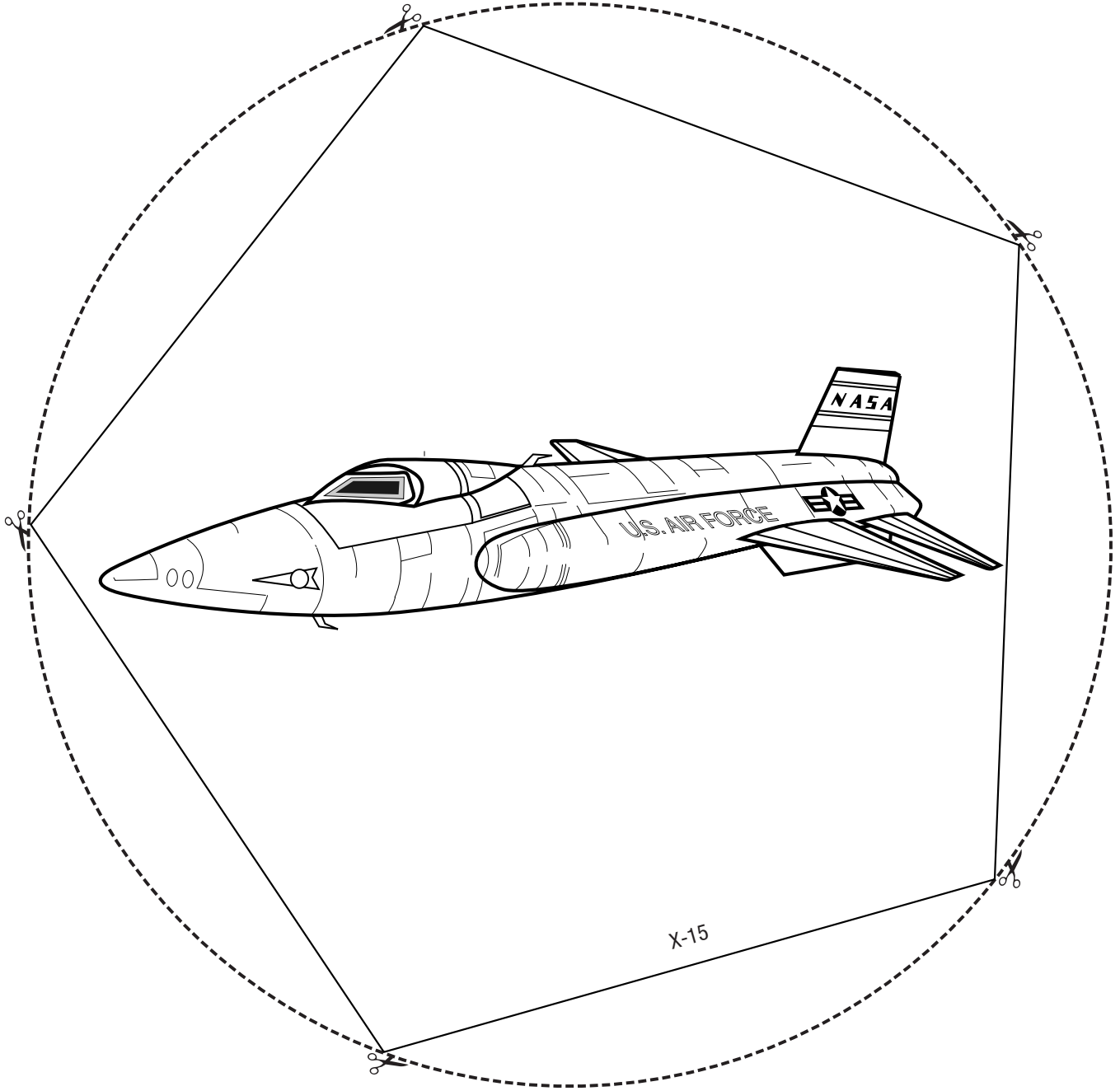

The X-15 was a rocket-powered airplane that flew to the edge of space. Some X-15 pilots earned astronaut wings. NASA no longer flies the X-15.

National Aeronautics and Space Administration  
**George C. Marshall Space Flight Center**  
Huntsville, AL 35812  
[www.nasa.gov/marshall](http://www.nasa.gov/marshall)

[www.nasa.gov](http://www.nasa.gov)

NP-2009-11-194-MSFC