

National Aeronautics and  
Space Administration  
Langley Research Center

Educational Product

Students

Grades K-5

EP-2003-12-07-LaRC

# ADVENTURES

in aeronautics

COLORING  
BOOK!

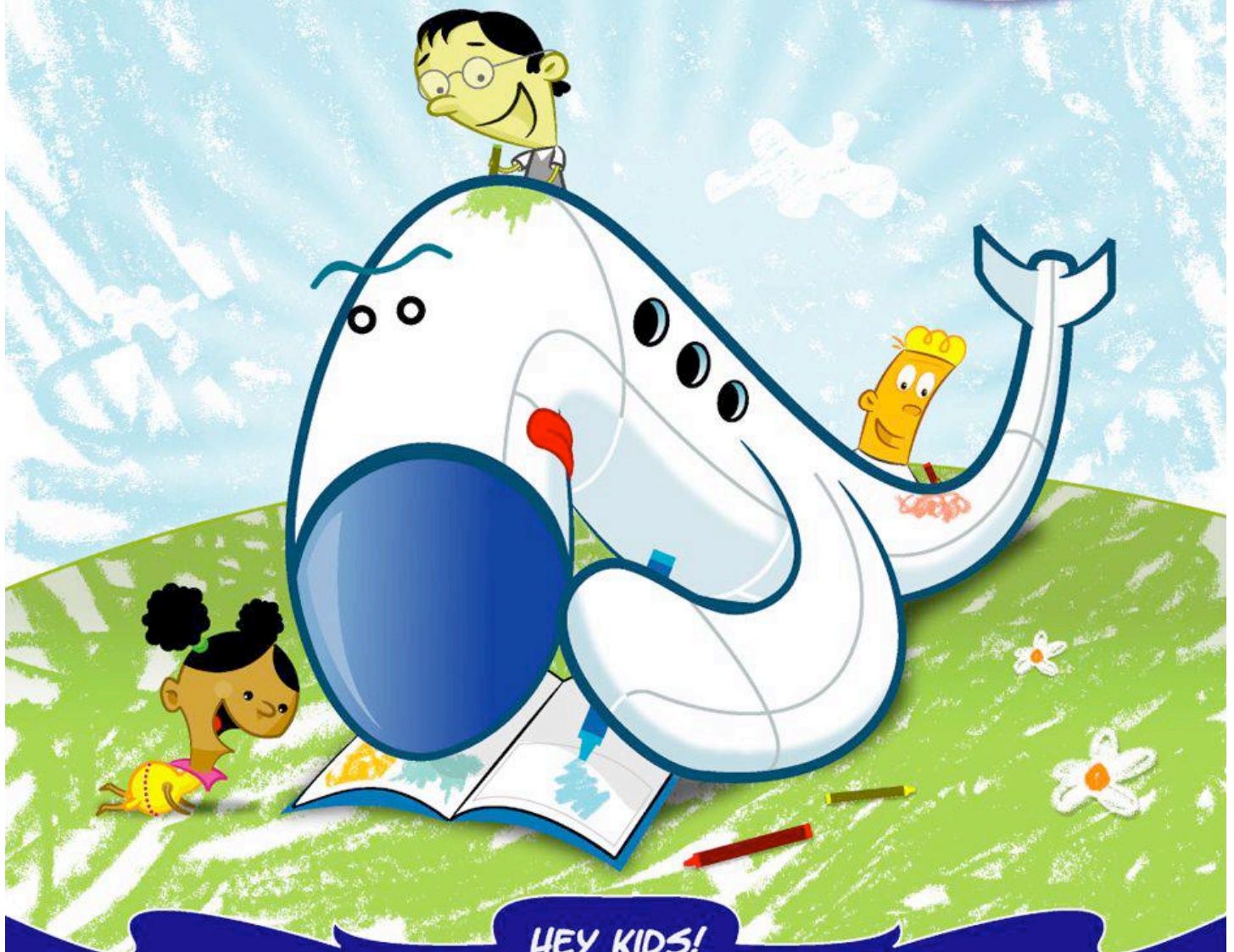

HEY KIDS!

GET YOUR **CRAYONS** AND TAKE A TRIP WITH F.A. PLANE AND FRIENDS!  
LEARN ABOUT THE FIRST "A" IN NASA, "AERONAUTICS!"



# AERONAUTICS *The science of flight that deals with all types of aircraft.*

This storybook about NASA Aeronautics is dedicated to all the future aviation professionals—the youngsters that are in school today. We hope this story will inspire them to learn more about the many aspects of flight and the many types of careers associated with the U.S. aviation industry.

## MATCH GAME!

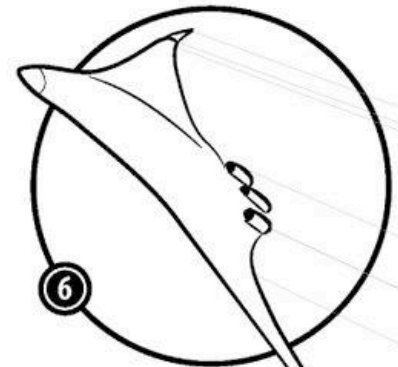
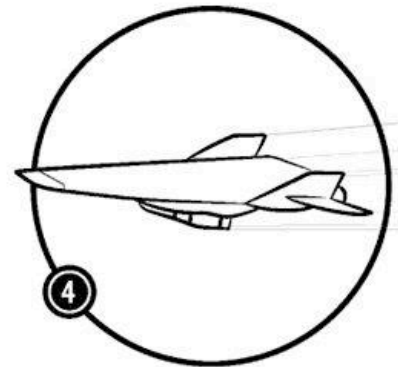
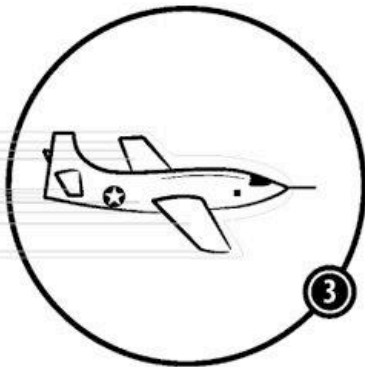
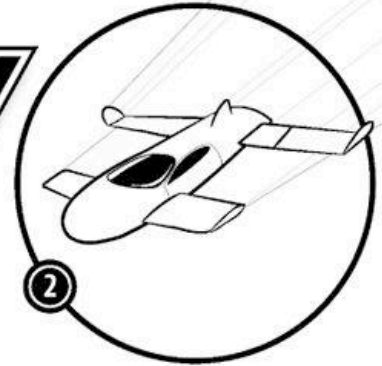
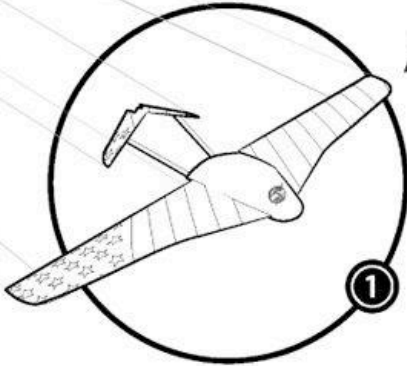

These images are taken from pages in this storybook. When you have finished reading the book, come back to test your knowledge of these types of aircraft. Match the image of the aircraft with its name in the storybook. The names of the planes are listed below, choose the number of the image that fits its name!

- A Personal Air Vehicle
- B Joint Strike Fighter
- C Hypersonic X-43 Plane
- D Blended Wing Body
- E X-1 Supersonic Plane
- F Mars Plane

Acknowledgements —  
 Original Idea & text for a museum storybook exhibit — Natalie S. Friend  
 Planners Collaborative Inc.  
 Illustrations & layout — Wade A. Mickley  
 NCI Information Systems

Answer key: A-2, B-5, C-4, D-6, E-3, F-1

IT'S A SUNNY DAY IN HAMPTON, VIRGINIA.



...SO WE'RE LEAVING TOMORROW.

WOW, ALL THE WAY TO HAWAII! WHAT A TRIP!



YEAH I GUESS SO.

NICKY, WHY THE LONG FACE?

HI ALEX. I WAS JUST TELLING KIM ABOUT OUR VACATION TO HAWAII.

DUDE, YOU DON'T LOOK HAPPY ABOUT IT.



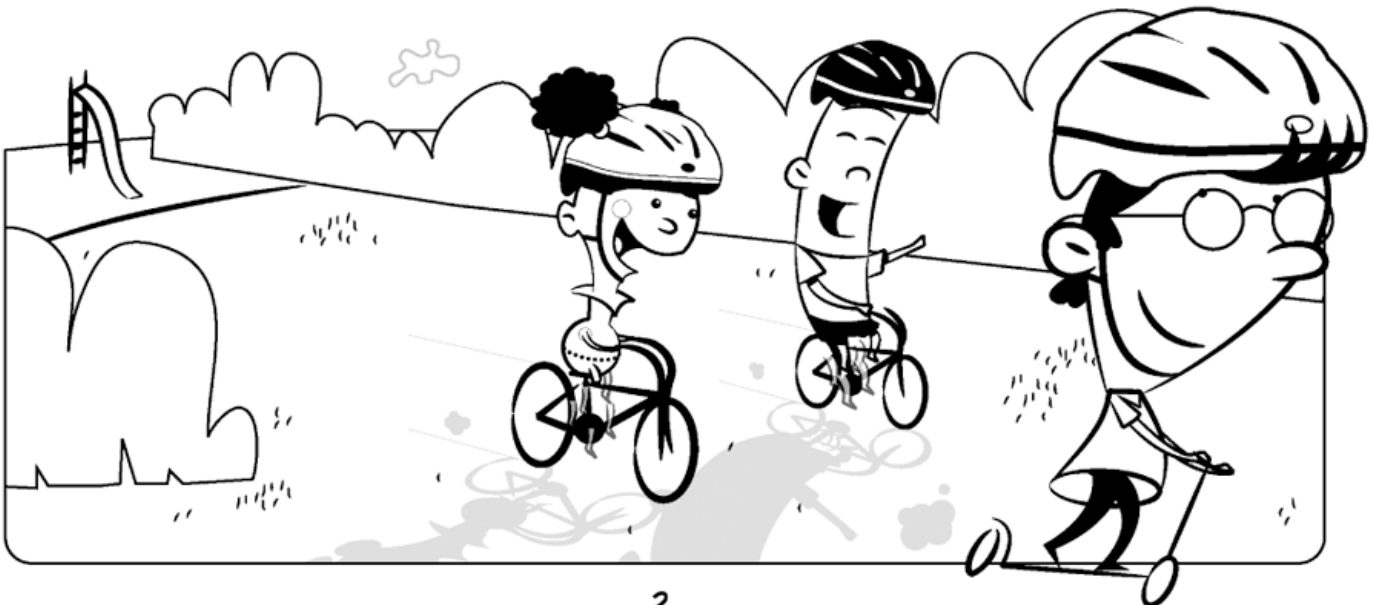
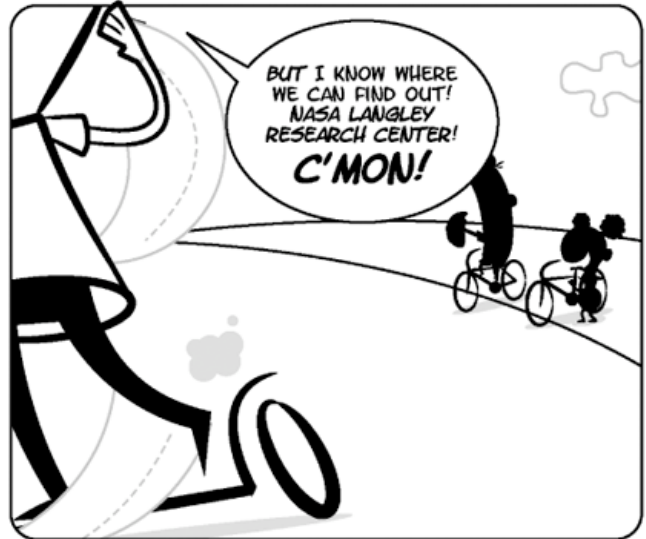
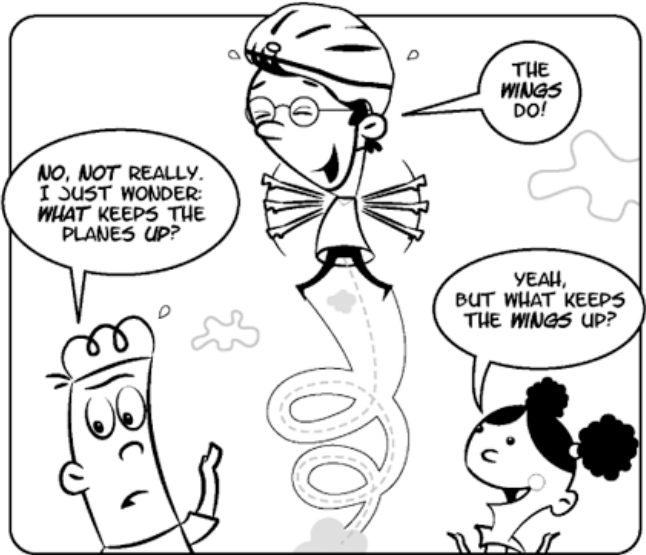

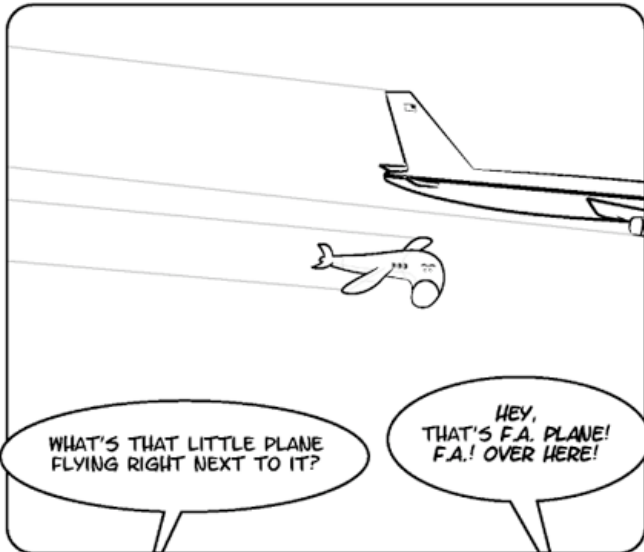
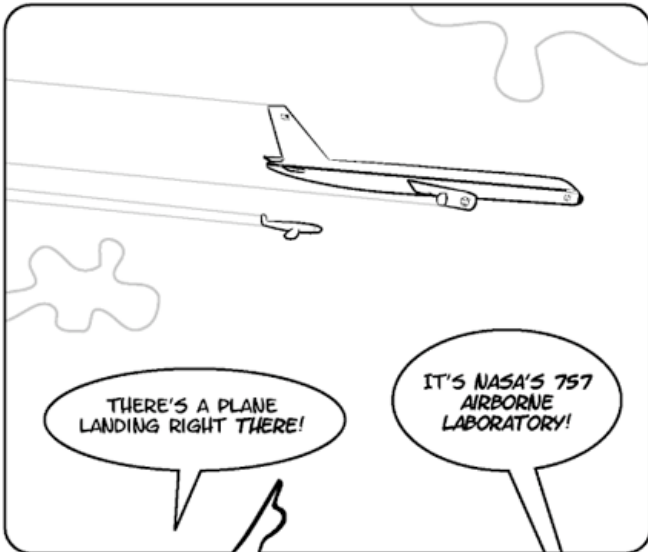

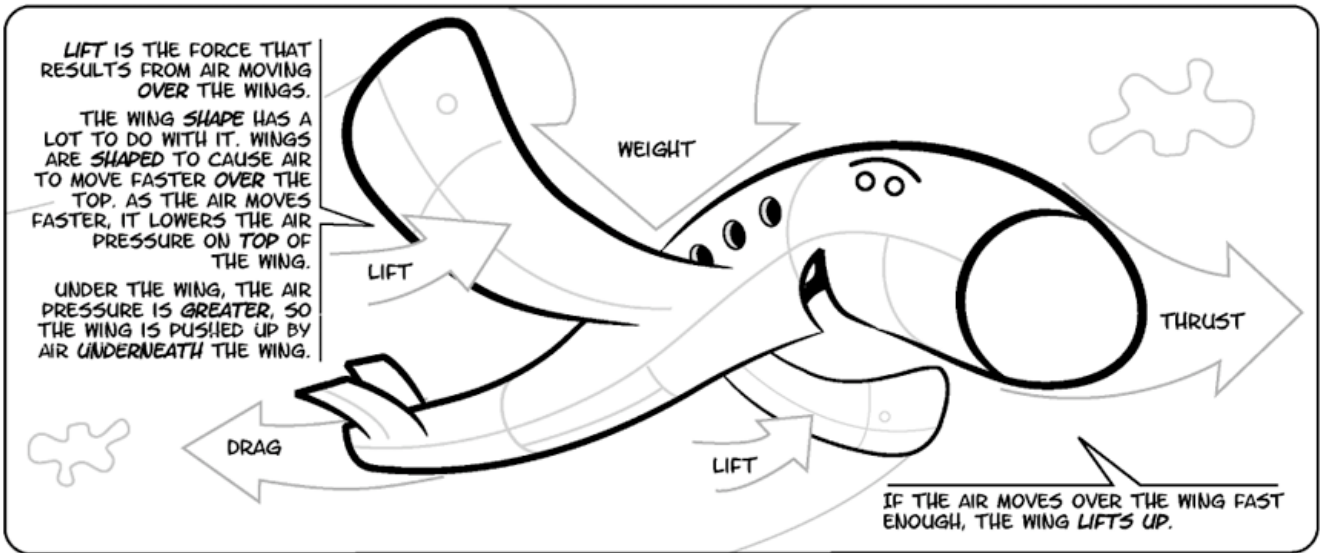
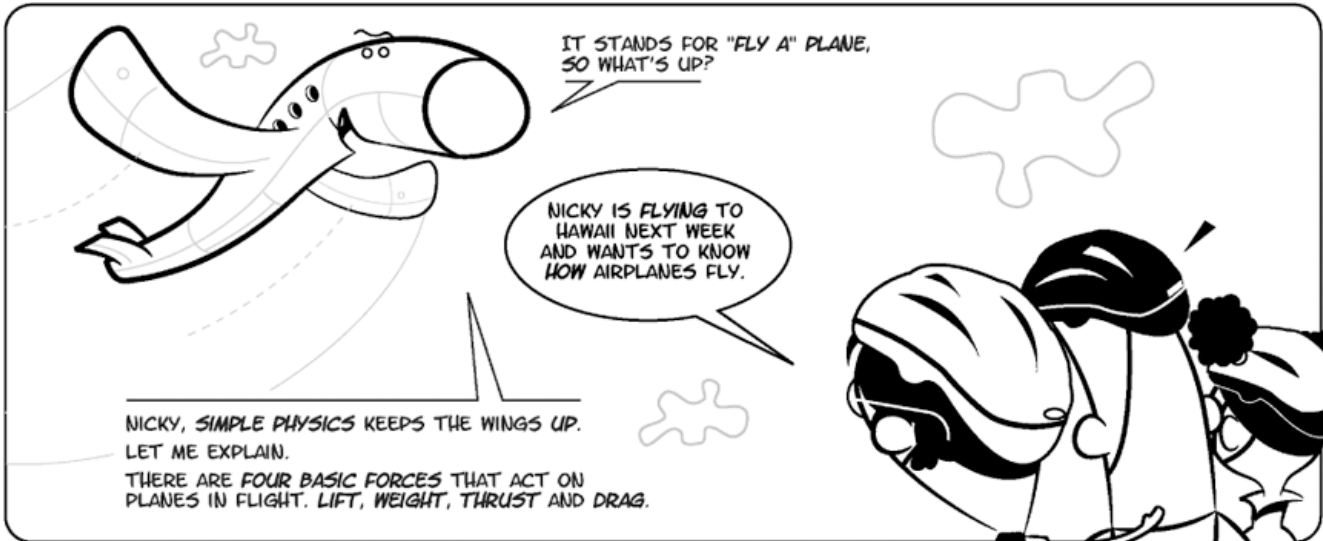
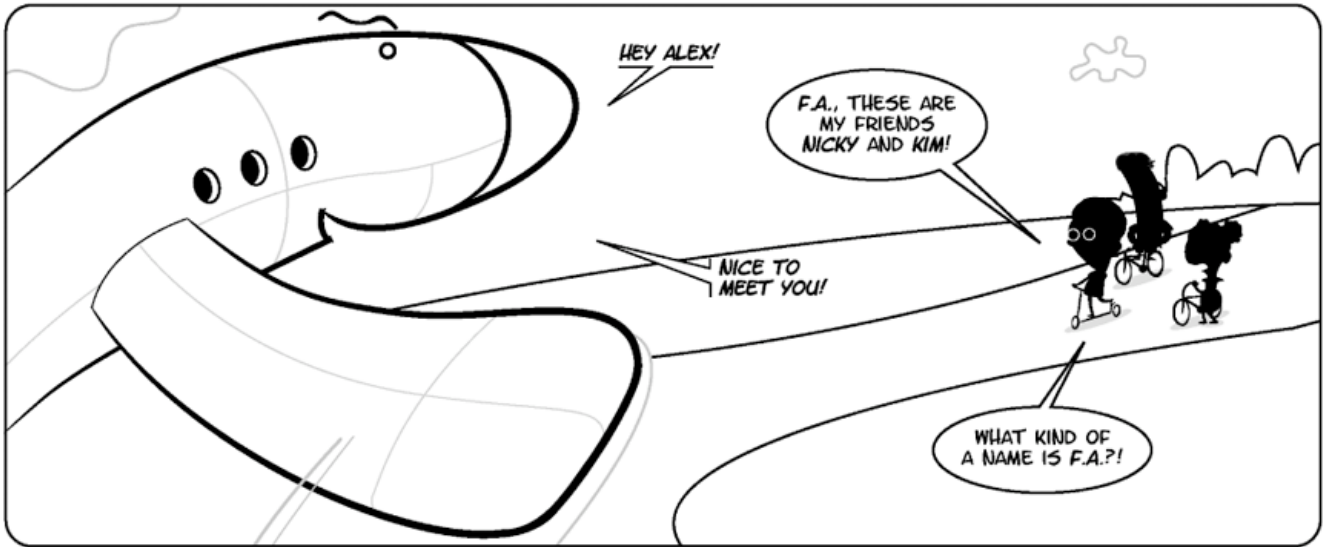



NICKY,  
HAVE YOU EVER HELD YOUR  
HAND OUT OF A CAR-WINDOW  
ON A TRIP?  
DO YOU REMEMBER HOW YOUR  
HAND LIFTED UP AS THE AIR  
MOVED PAST IT? THAT IS  
SIMILAR TO THE FORCE THAT  
KEEPS THE WINGS UP--LIFT.

I GET IT!  
CAN YOU EXPLAIN  
THE OTHER  
FORCES F.A.?



SURE, BUT HOW ABOUT WE  
SEE SOME OF THE THINGS  
THAT NASA LANGLEY DOES  
WITH AIRPLANES FIRST?

OK, THAT WOULD  
BE GREAT!

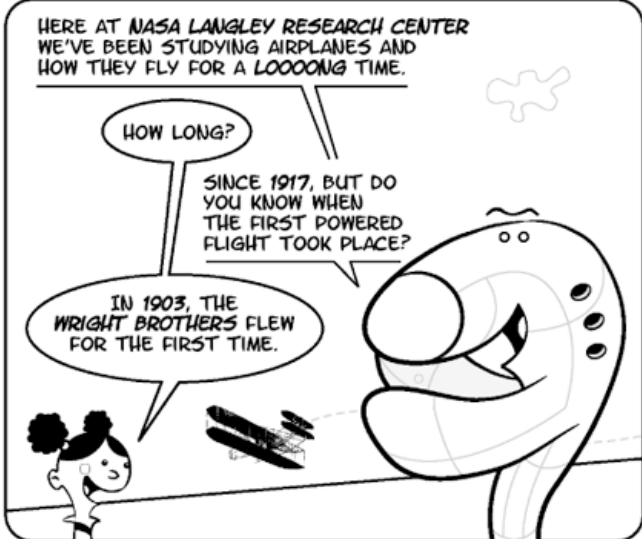

HERE AT NASA LANGLEY RESEARCH CENTER  
WE'VE BEEN STUDYING AIRPLANES AND  
HOW THEY FLY FOR A LOOOONG TIME.

HOW LONG?

SINCE 1917, BUT DO  
YOU KNOW WHEN  
THE FIRST POWERED  
FLIGHT TOOK PLACE?

IN 1903, THE  
WRIGHT BROTHERS FLEW  
FOR THE FIRST TIME.

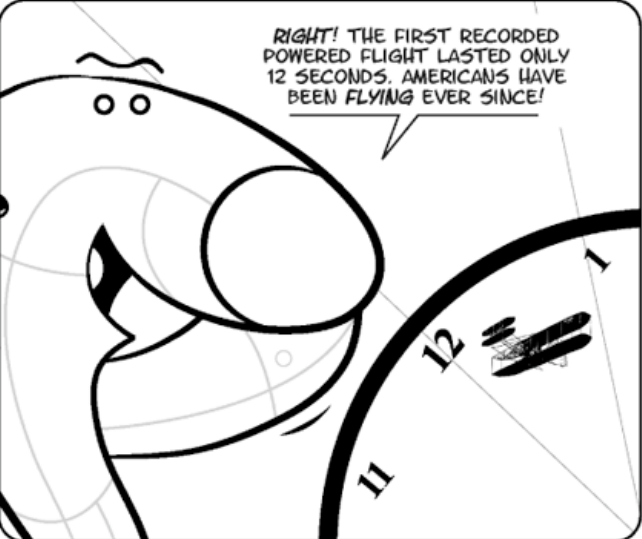

RIGHT! THE FIRST RECORDED  
POWERED FLIGHT LASTED ONLY  
12 SECONDS. AMERICANS HAVE  
BEEN FLYING EVER SINCE!

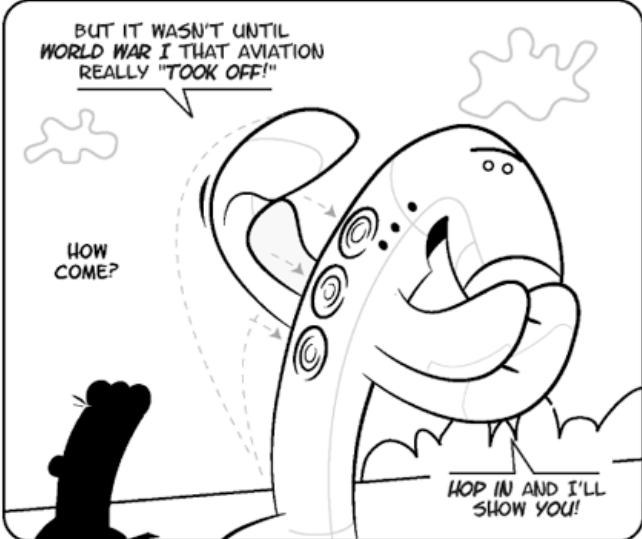

BUT IT WASN'T UNTIL  
WORLD WAR I THAT AVIATION  
REALLY "TOOK OFF!"

HOW  
COME?

HOP IN AND I'LL  
SHOW YOU!

DURING **WORLD WAR I** PEOPLE REALIZED THAT YOU COULD TAKE **PICTURES** OF THE BATTLEFIELD FROM THE AIR. THESE PICTURES GAVE IMPORTANT INFORMATION ABOUT ENEMY POSITIONS TO SOLDIERS ON THE GROUND.

WOW, YOU CAN SEE EVERYTHING FROM UP HERE!

THAT WAS THE IDEA NICKY.

EACH SIDE TRIED TO KEEP THE OTHER FROM GETTING GOOD PICTURES.

PILOTS STARTED **THROWING** THINGS AT EACH OTHER, AND EVENTUALLY THEY MOUNTED **MACHINE GUNS** TO THEIR PLANES.

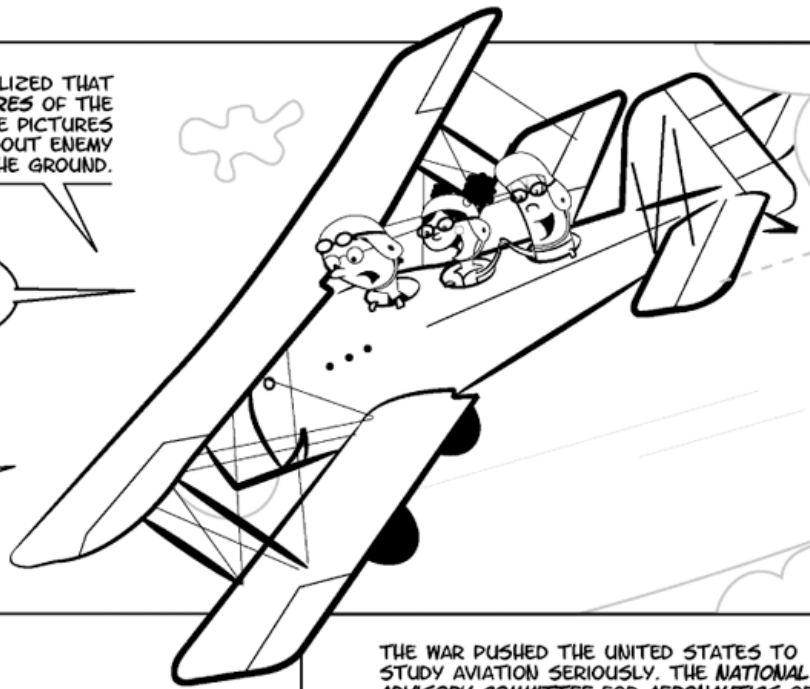

LIKE THE RED BARON?

EXACTLY! WORLD WAR I SAW THE BIRTH OF AIR COMBAT.

I THINK THAT GUY SEES US!

WE BETTER GET OUT OF HERE!

THE WAR PUSHED THE UNITED STATES TO STUDY AVIATION SERIOUSLY. THE NATIONAL ADVISORY COMMITTEE FOR AERONAUTICS OR NACA WAS ESTABLISHED IN 1915.

TWO YEARS LATER, LANGLEY AERONAUTICAL LABORATORY WAS FOUNDED IN HAMPTON, VA.



NACA IS WHAT EVENTUALLY BECAME THE NATIONAL AERONAUTICS AND SPACE ADMINISTRATION, THE NASA THAT WE KNOW TODAY.

WHAT AIRPLANE IS THAT?!

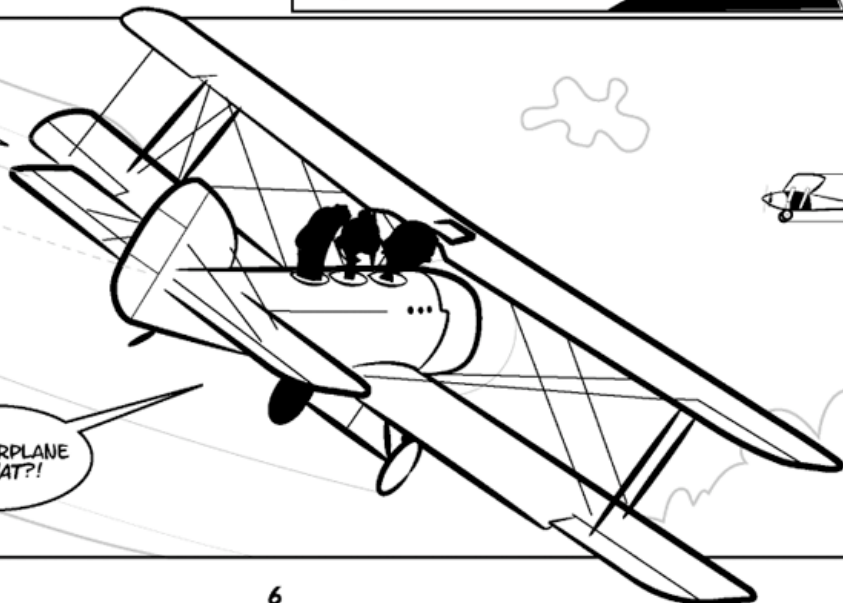

THAT'S THE SPIRIT OF SAINT LOUIS. WE'RE USED TO FLYING ACROSS THE OCEANS, BUT CHARLES LINDBERGH WAS THE FIRST ONE TO FLY NON-STOP ACROSS THE ATLANTIC OCEAN IN 1927.

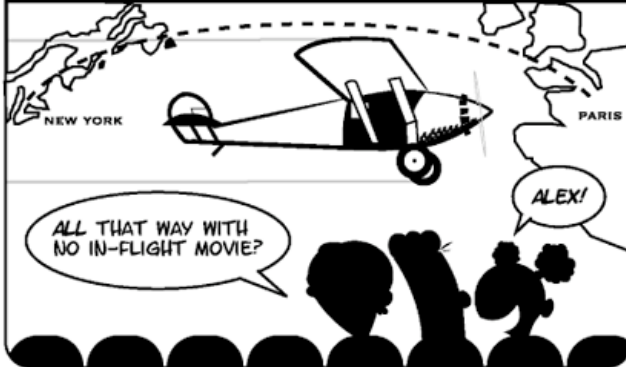

AFTER THE WAR, LANGLEY BUILT A WIND TUNNEL SO BIG YOU COULD PUT A FULL-SIZE PLANE IN IT. THERE ARE MORE THAN 20 WIND TUNNELS AT LANGLEY.

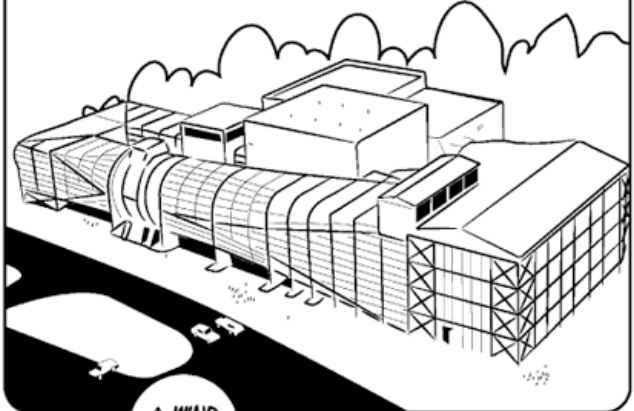

A WIND TUNNEL?

A WIND TUNNEL IS AN ENCLOSED AREA WHERE AIR IS MOVED OVER AN AIRPLANE, KIM. AIRPLANES, OR MODELS OF AIRPLANES, CAN BE TESTED IN WIND TUNNELS TO SEE HOW THEY PERFORM BEFORE THEY FLY IN THE SKY.

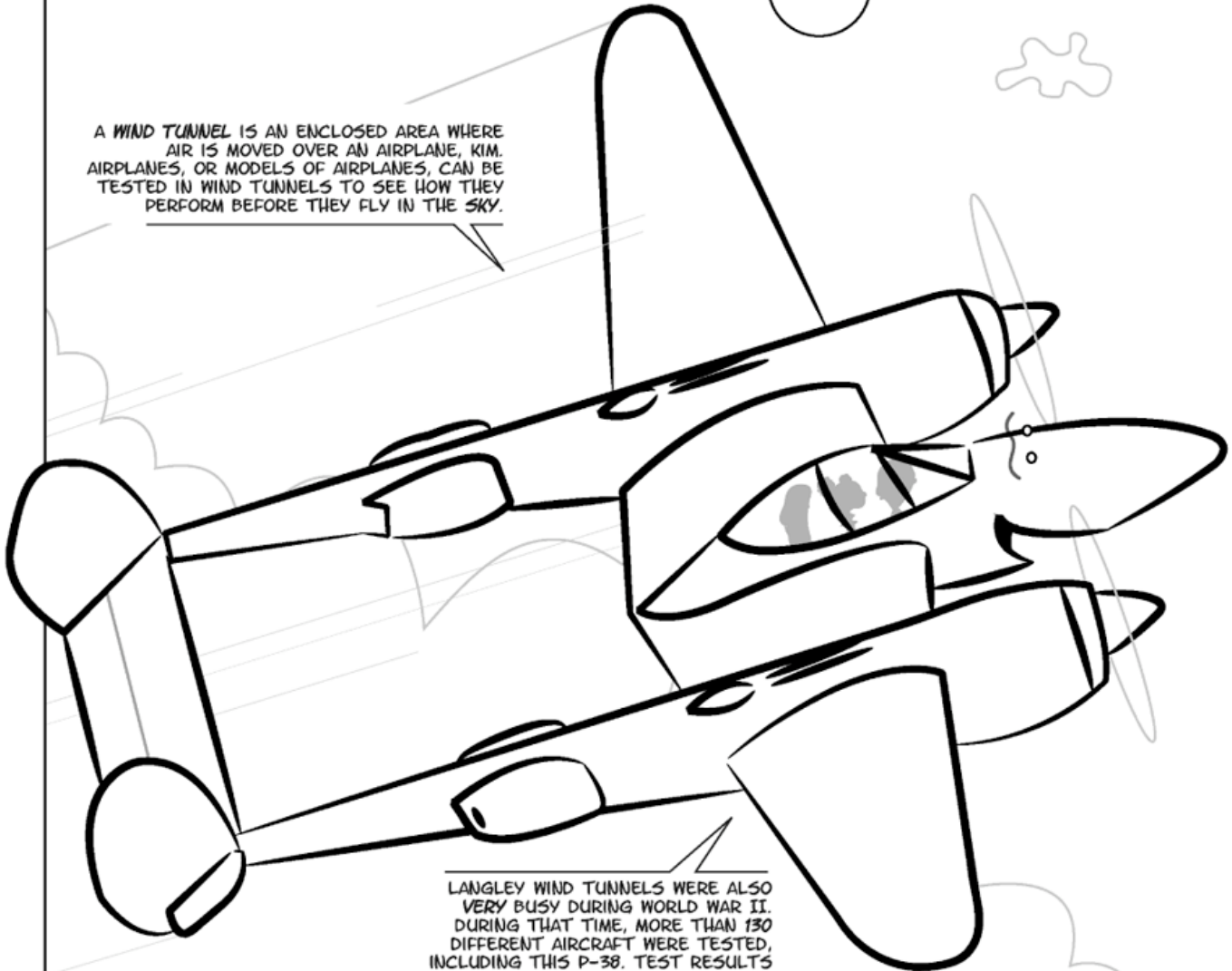

LANGLEY WIND TUNNELS WERE ALSO VERY BUSY DURING WORLD WAR II. DURING THAT TIME, MORE THAN 130 DIFFERENT AIRCRAFT WERE TESTED, INCLUDING THIS P-38. TEST RESULTS WERE USED TO MAKE BETTER PLANES.



WHAT ABOUT AFTER THE WAR?

PEOPLE WANTED TO GO FASTER, BUT THEY THOUGHT PLANES COULD NEVER GO AS FAST AS THE SPEED OF SOUND. IN 1947, A MILITARY TEST PILOT NAMED CHUCK YEAGER FLEW THE ROCKET-POWERED X-1 PLANE FASTER THAN SOUND!

NACA ENGINEERS HELPED TO DESIGN THE X-1.



FASTER THAN SOUND! THAT DOESN'T SOUND GOOD TO ME.



RELAX NICKY! THE PLANE THAT YOU WILL RIDE IN TO HAWAII WON'T GO THAT FAST, WILL IT F.A.?

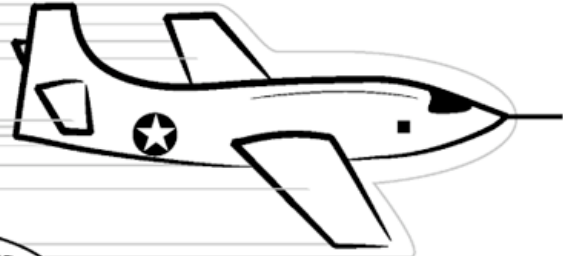

RIGHT ALEX! BUT SOME MILITARY PLANES GO FASTER THAN SOUND.

WHEN A PLANE GOES FASTER THAN SOUND, IT MAKES A LOUD NOISE CALLED A SONIC BOOM. PEOPLE ON THE GROUND DON'T LIKE TO HEAR THAT.



**BOOM!**



THE LOUD NOISE CAN BREAK WINDOWS AND HURT PEOPLE'S EARS. SO MOST AIRLINERS DON'T GO THAT FAST!



THERE WAS A WHOLE SERIES OF X PLANES, NICKY. TEST PILOTS FLEW HIGHER AND FASTER THAN EVER BEFORE.

KNOW WHAT HAPPENED NEXT?

SPUTNIK!

RIGHT!

YOU'RE NOT THE ONLY ONE WHO KNOWS STUFF, ALEX



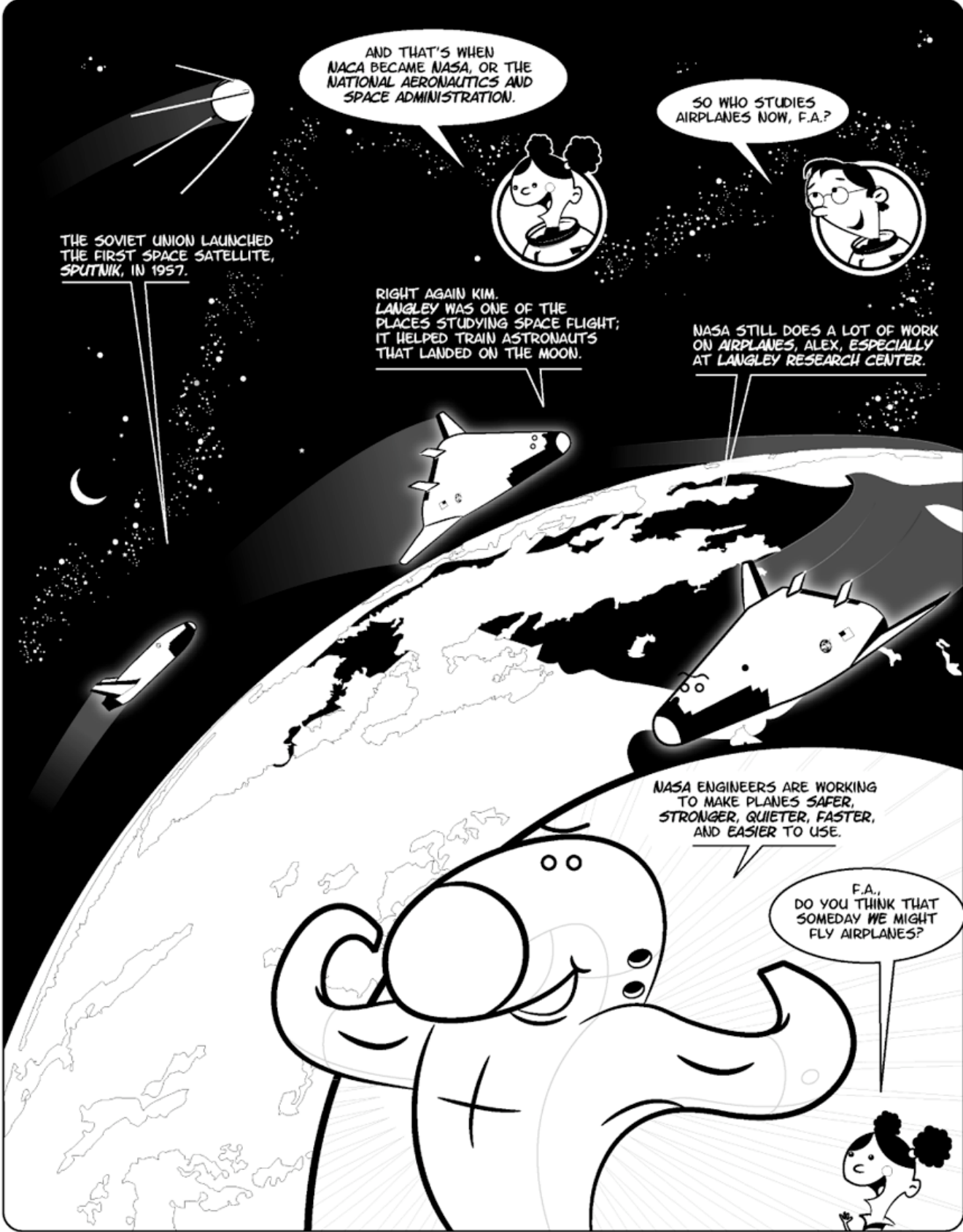

AND THAT'S WHEN NACA BECAME NASA, OR THE NATIONAL AERONAUTICS AND SPACE ADMINISTRATION.

SO WHO STUDIES AIRPLANES NOW, F.A.?

THE SOVIET UNION LAUNCHED THE FIRST SPACE SATELLITE, SPUTNIK, IN 1957.

RIGHT AGAIN KIM. LANGLEY WAS ONE OF THE PLACES STUDYING SPACE FLIGHT; IT HELPED TRAIN ASTRONAUTS THAT LANDED ON THE MOON.

NASA STILL DOES A LOT OF WORK ON AIRPLANES, ALEX, ESPECIALLY AT LANGLEY RESEARCH CENTER.

NASA ENGINEERS ARE WORKING TO MAKE PLANES SAFER, STRONGER, QUIETER, FASTER, AND EASIER TO USE.

F.A., DO YOU THINK THAT SOMEDAY WE MIGHT FLY AIRPLANES?

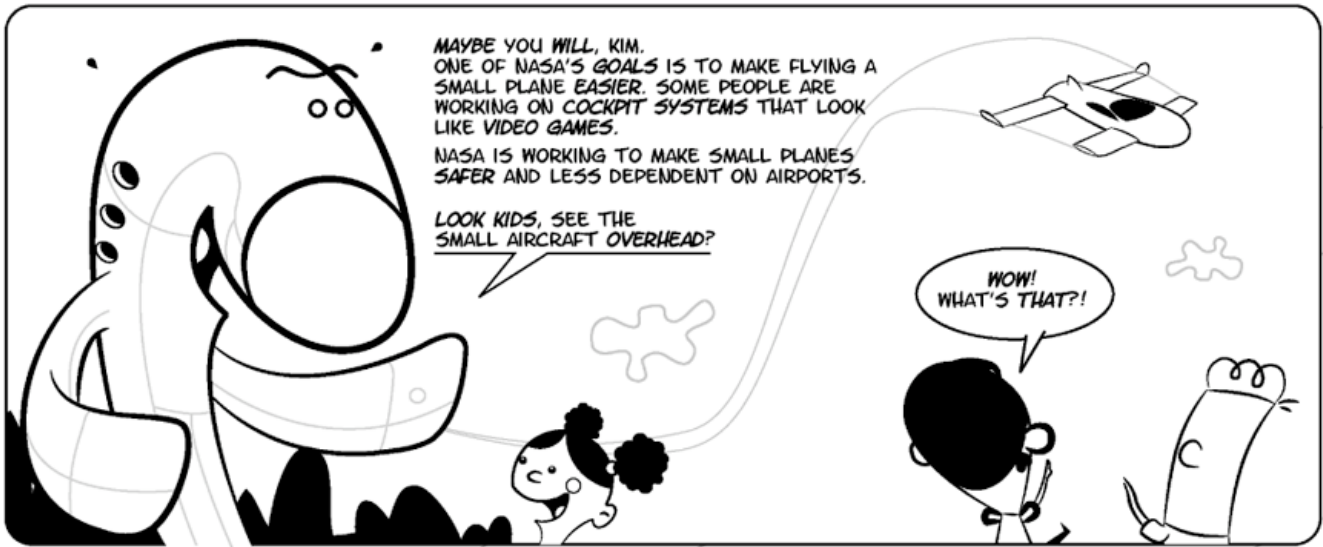

MAYBE YOU WILL, KIM. ONE OF NASA'S GOALS IS TO MAKE FLYING A SMALL PLANE EASIER. SOME PEOPLE ARE WORKING ON COCKPIT SYSTEMS THAT LOOK LIKE VIDEO GAMES.

NASA IS WORKING TO MAKE SMALL PLANES SAFER AND LESS DEPENDENT ON AIRPORTS.

LOOK KIDS, SEE THE SMALL AIRCRAFT OVERHEAD?

WOW!  
WHAT'S THAT?!

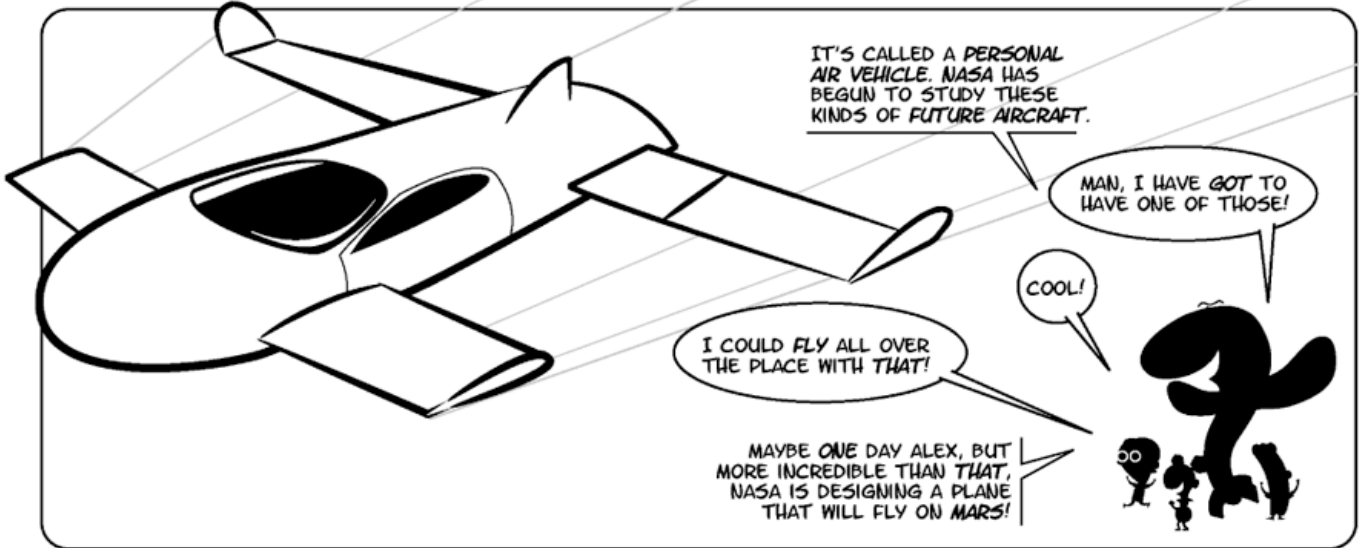

IT'S CALLED A PERSONAL AIR VEHICLE. NASA HAS BEGUN TO STUDY THESE KINDS OF FUTURE AIRCRAFT.

MAN, I HAVE GOT TO HAVE ONE OF THOSE!

COOL!

I COULD FLY ALL OVER THE PLACE WITH THAT!

MAYBE ONE DAY ALEX, BUT MORE INCREDIBLE THAN THAT, NASA IS DESIGNING A PLANE THAT WILL FLY ON MARS!

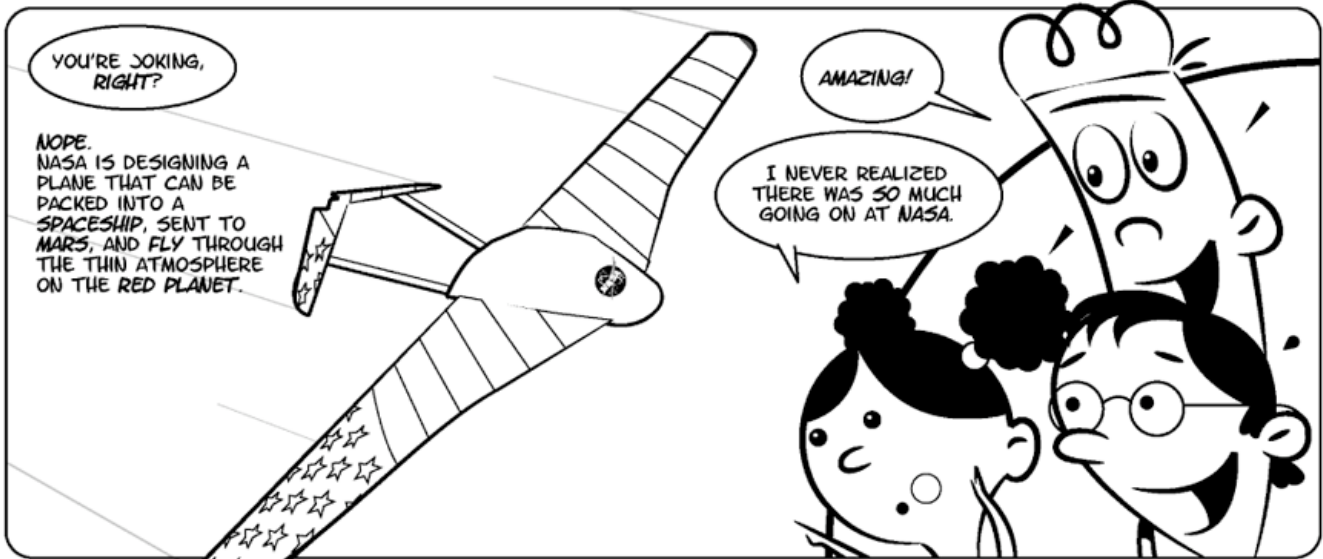

YOU'RE JOKING, RIGHT?

NOPE. NASA IS DESIGNING A PLANE THAT CAN BE PACKED INTO A SPACESHIP, SENT TO MARS, AND FLY THROUGH THE THIN ATMOSPHERE ON THE RED PLANET.

AMAZING!

I NEVER REALIZED THERE WAS SO MUCH GOING ON AT NASA.

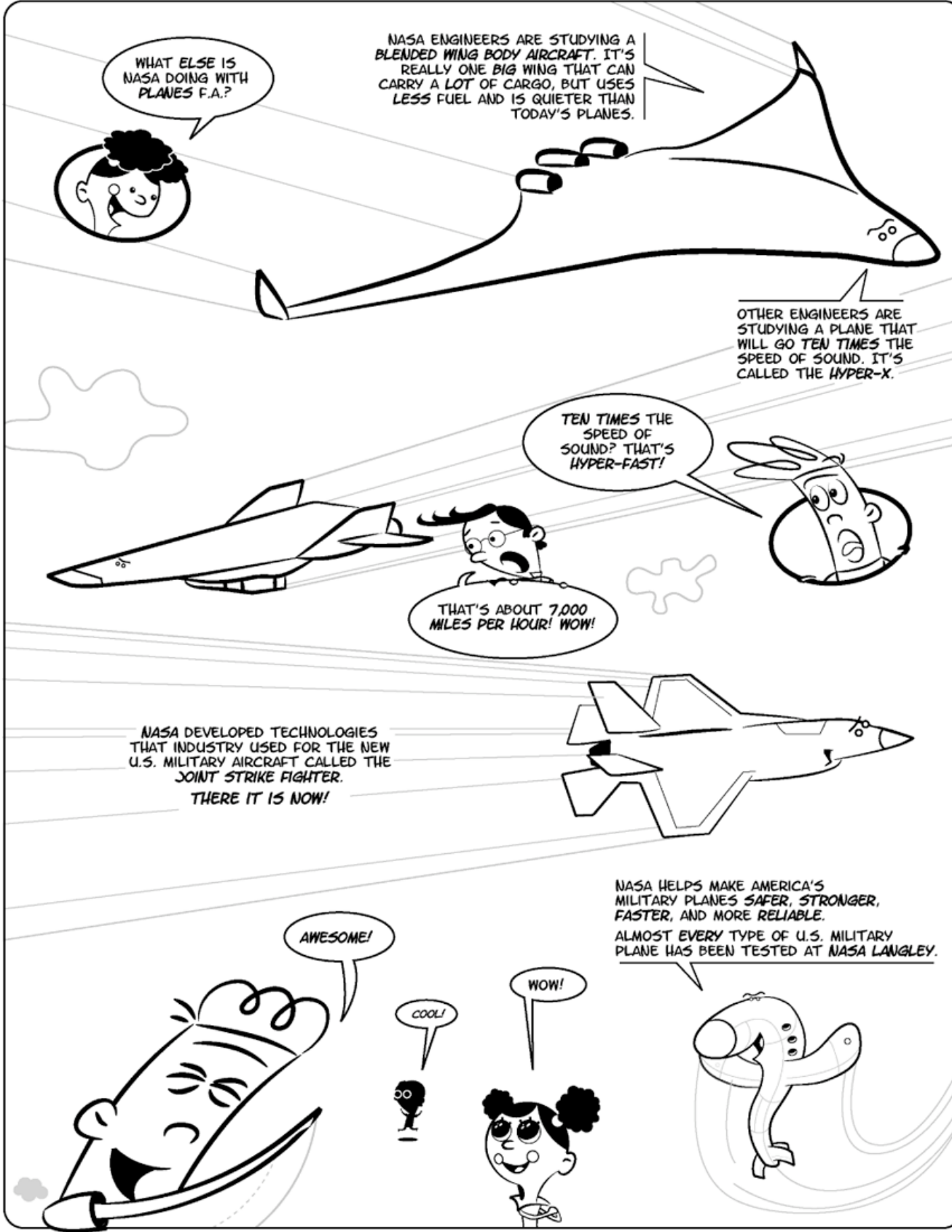

WHAT ELSE IS NASA DOING WITH PLANES F.A.?

NASA ENGINEERS ARE STUDYING A BLENDED WING BODY AIRCRAFT. IT'S REALLY ONE BIG WING THAT CAN CARRY A LOT OF CARGO, BUT USES LESS FUEL AND IS QUIETER THAN TODAY'S PLANES.

OTHER ENGINEERS ARE STUDYING A PLANE THAT WILL GO TEN TIMES THE SPEED OF SOUND. IT'S CALLED THE HYPER-X.

TEN TIMES THE SPEED OF SOUND? THAT'S HYPER-FAST!

THAT'S ABOUT 7,000 MILES PER HOUR! WOW!

NASA DEVELOPED TECHNOLOGIES THAT INDUSTRY USED FOR THE NEW U.S. MILITARY AIRCRAFT CALLED THE JOINT STRIKE FIGHTER. THERE IT IS NOW!

NASA HELPS MAKE AMERICA'S MILITARY PLANES SAFER, STRONGER, FASTER, AND MORE RELIABLE. ALMOST EVERY TYPE OF U.S. MILITARY PLANE HAS BEEN TESTED AT NASA LANGLEY.

AWESOME!

COOL!

WOW!

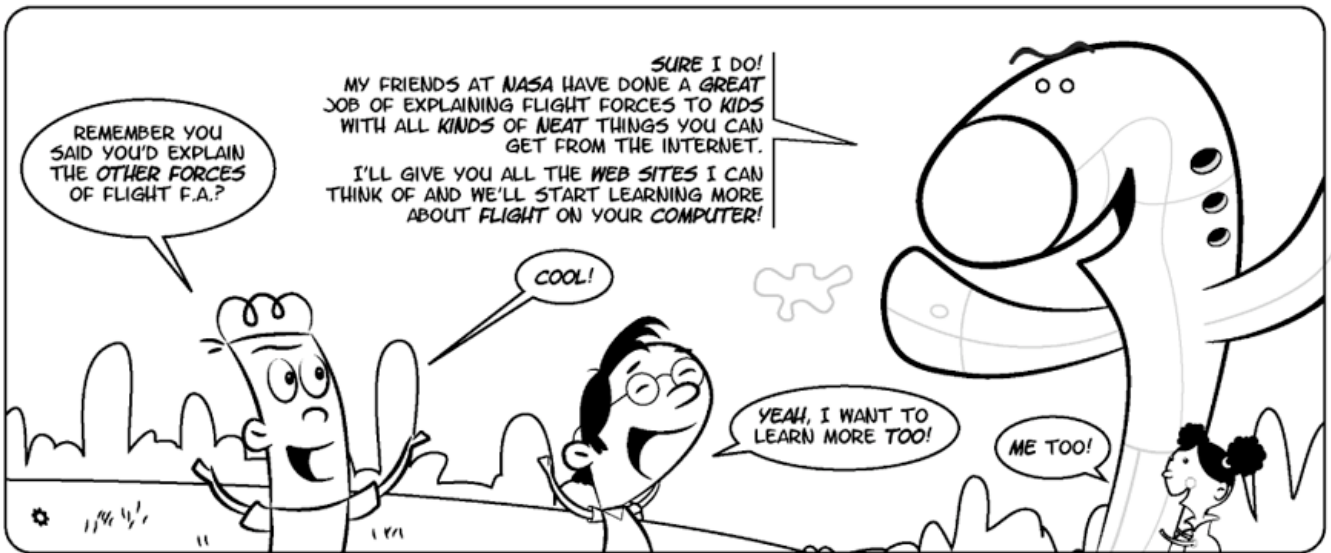
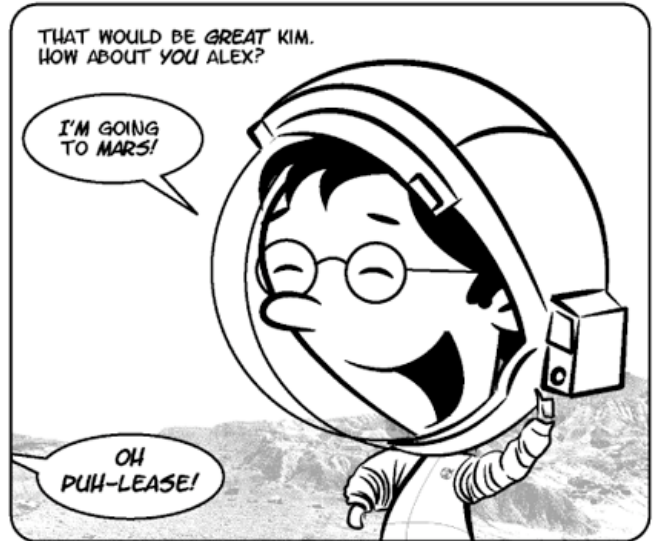
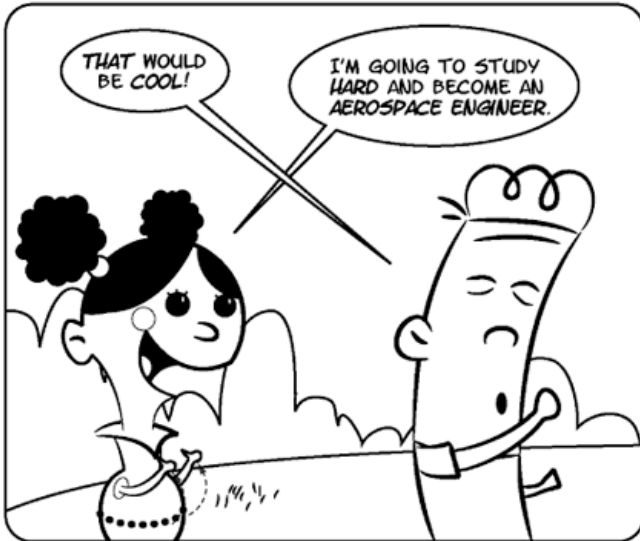
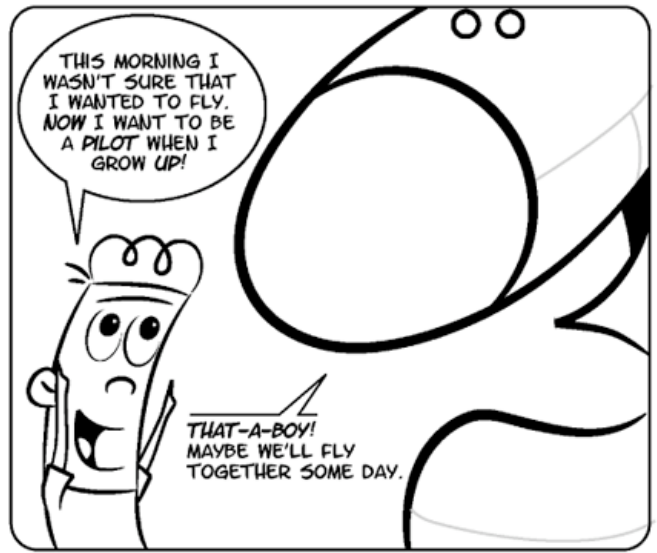

NASA has many web sites that can help you to learn more about flight. Some are listed below and others can be found by doing a search on the web for the topic that interests you most!

### Resources for Students and Educators of Grades K -12

#### Aerospace Technology Education Programs

<http://www.aero-space.nasa.gov/edu/2aero.html>

#### Aerospace Education Services Program (AESP)

<http://www.okstate.edu/aesp/AESP.html>

#### NASA Explorer Schools

<http://www.nsta.org/explorerschools>

#### NASA Student Involvement Program (NSIP)

<http://www.nsip.net>

#### NASA Explores

<http://NASAexplores.com>

#### NASA Educator Resource Network

<http://spacelink.nasa.gov/ercn/>

#### NASA Revolutionary Vehicles Student Competition

<http://avst.larc.nasa.gov/competition.html>

### Other web sites that may interest all age groups

#### The NASA Home Page Address

<http://www.nasa.gov>

#### NASA's Education Home Page

<http://education.nasa.gov>

#### NASA Langley Research Center

<http://www.larc.nasa.gov>



OKAY, HERE'S SOME PLACES TO  
START OUR NEXT ADVENTURE!

HEY KIDS!  
TURN THE PAGE FOR  
COLORING AND GAMES!

# F.A. PLANE AND FRIENDS!

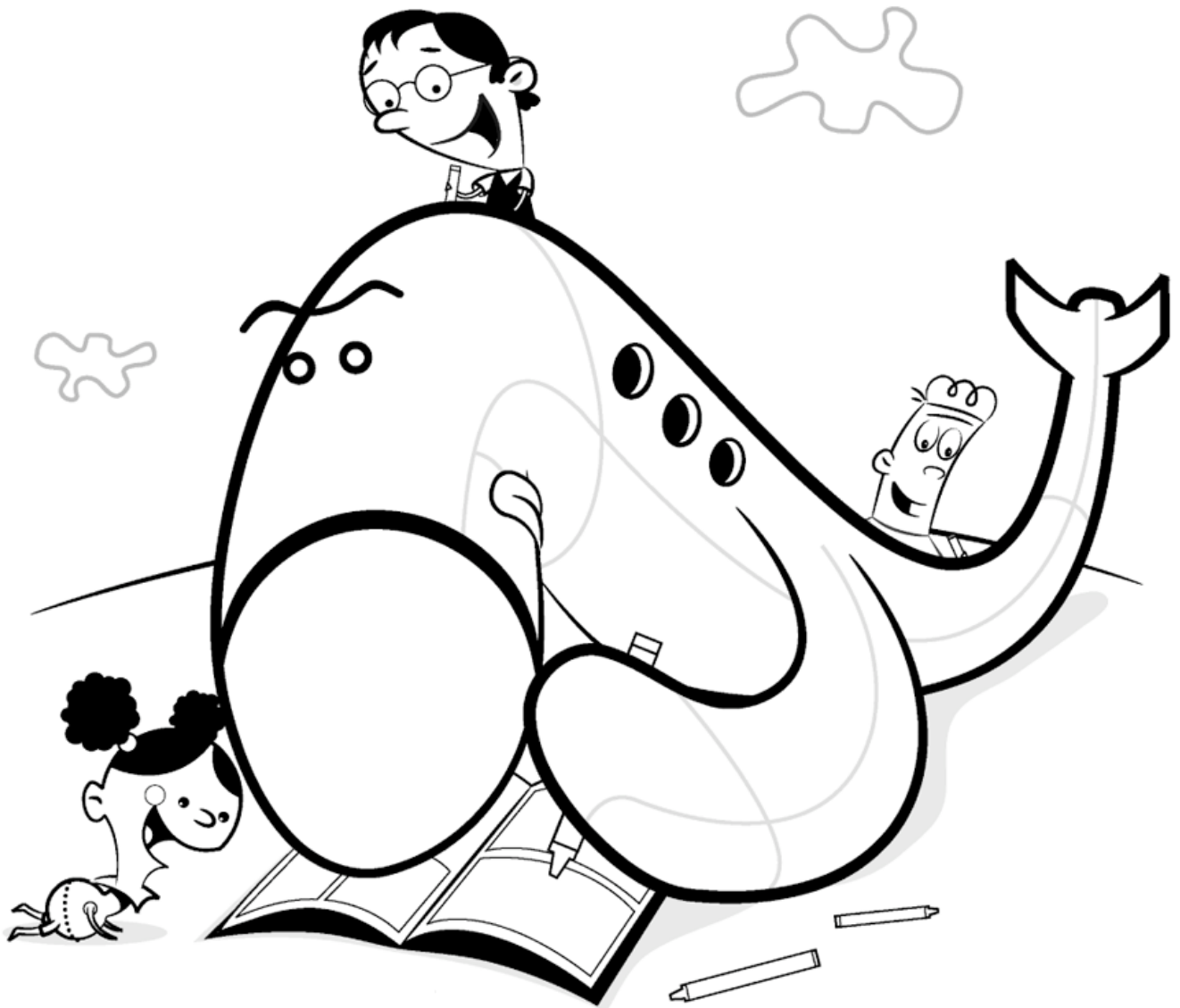

**HELP F.a. PLANE FIND HIS WAY TO  
NASA LANGLEY RESEARCH CENTER!**

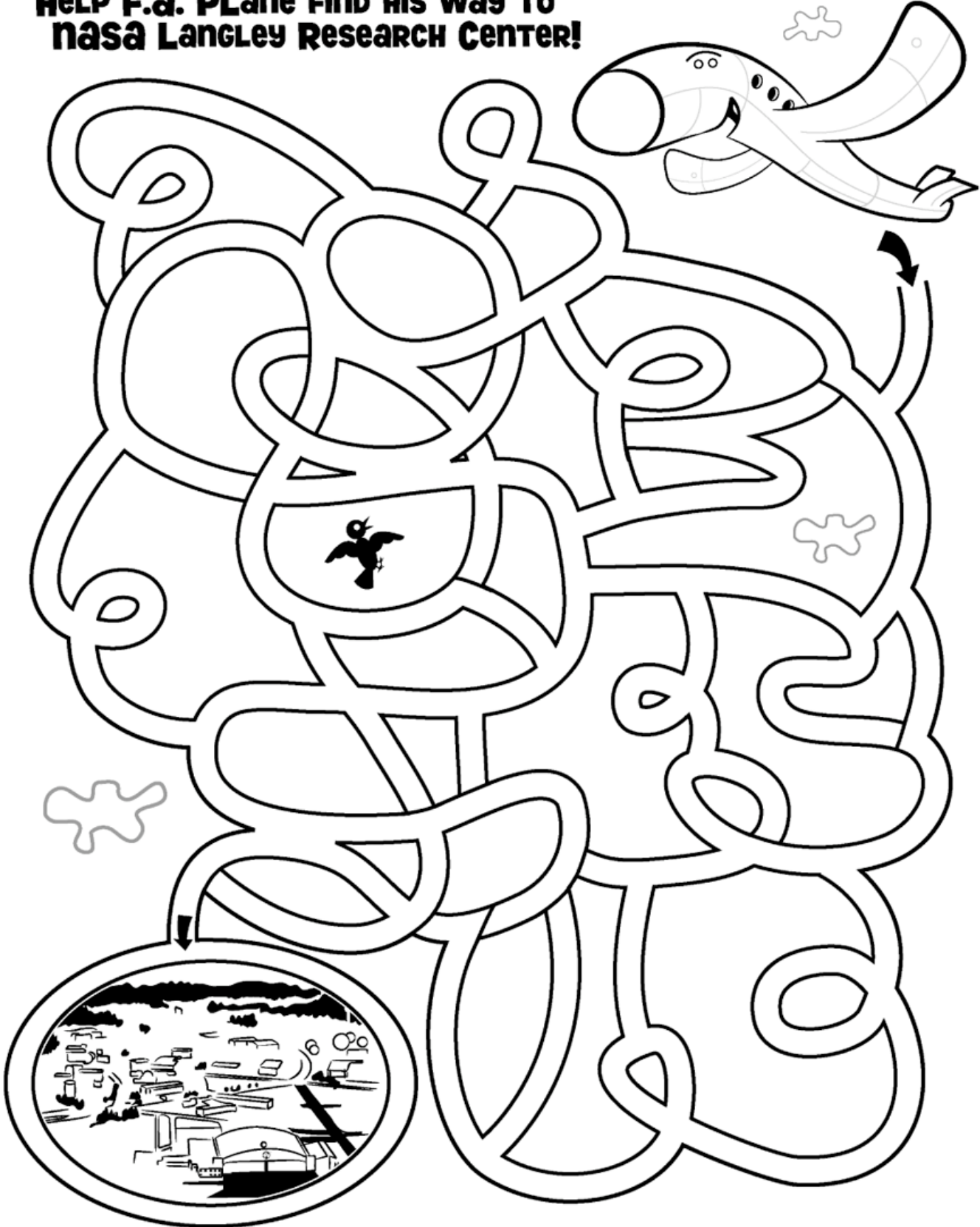





7.



2.



10.

11.

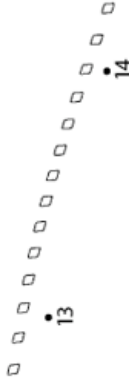

12.



23.

24.

15.

22.

21.

16.

19.

20.

17.

18.

*THE BLENDED-WING BODY AIRCRAFT*  
**FOLLOW THE NUMBERS TO  
CONNECT THE DOTS!**

KIM!



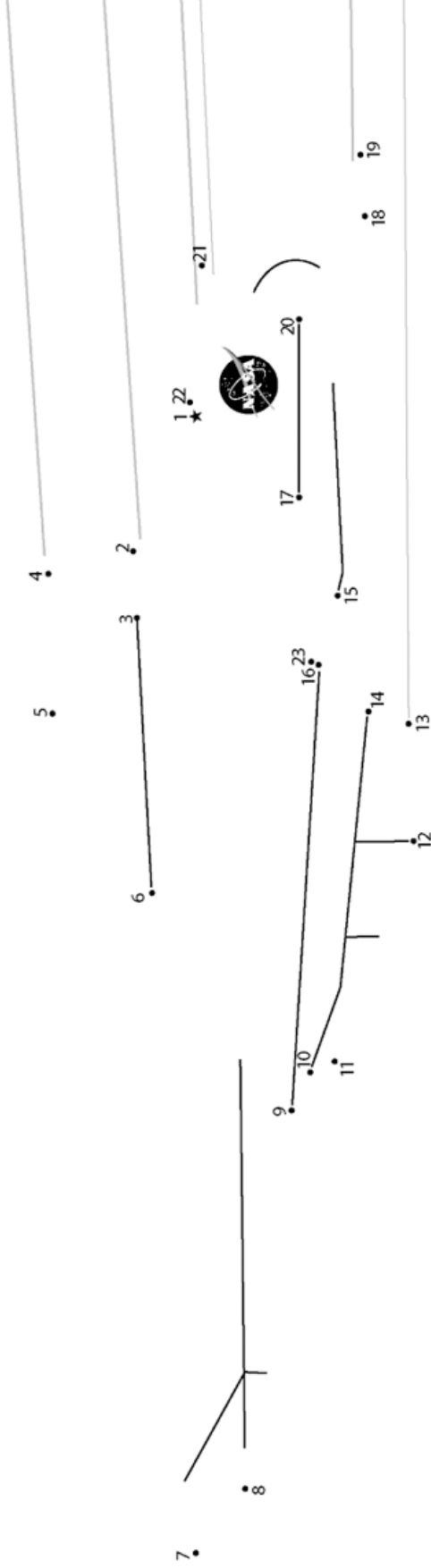

THE HYPER-X PLANE

**FOLLOW THE NUMBERS TO  
CONNECT THE DOTS!**

NICK!

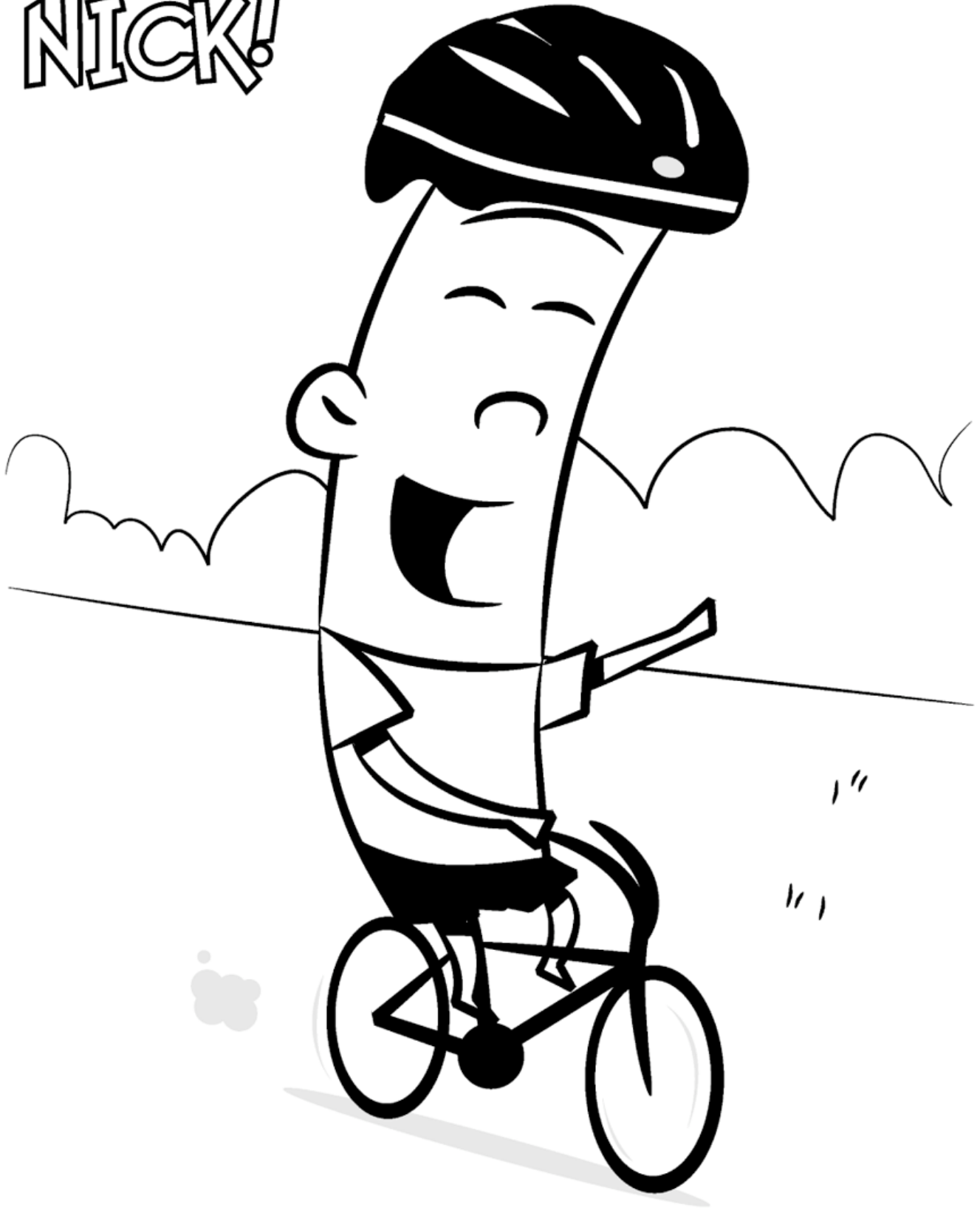

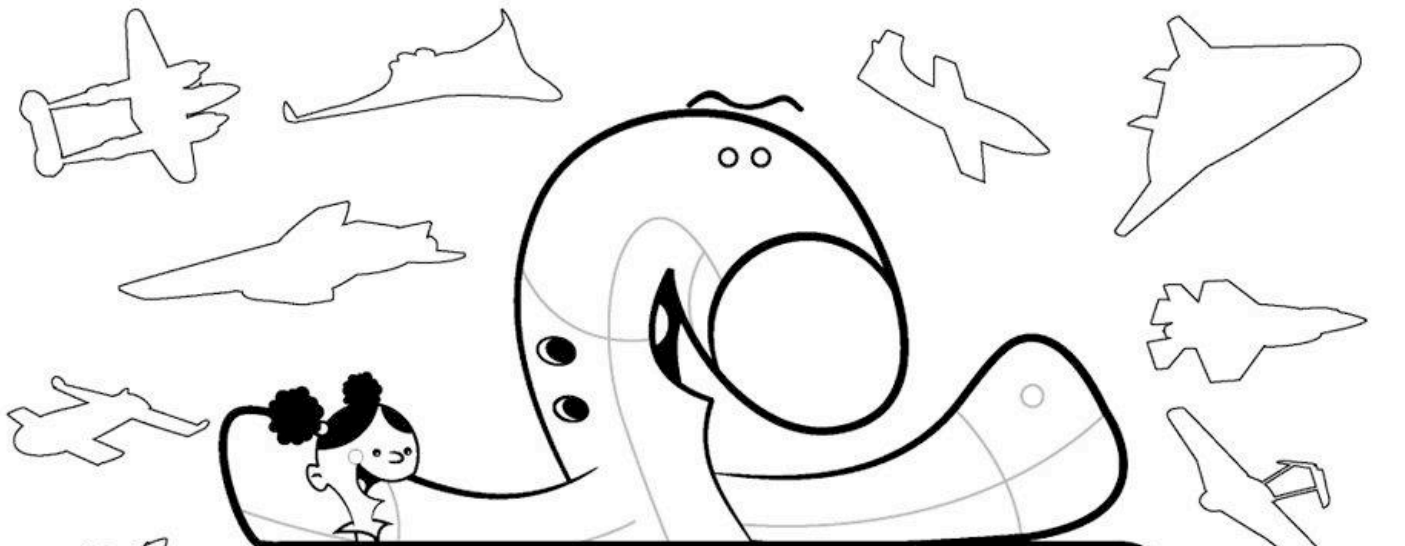

## WORD SEARCH!

Find the words below that have been hidden in the grid on the right!

- FLYING
- SUPERSONIC
- FLIGHT
- NASA
- PILOT
- HYPERSONIC
- BIPLANE
- LIFT
- ASTRONAUT
- XPLANE

A	E	A	H	T	R	T	I	E	S	R
G	L	S	E	E	R	I	H	S	S	O
I	I	T	N	L	O	X	Y	L	U	E
I	F	R	E	T	P	P	P	X	P	X
P	T	O	A	P	I	L	E	H	E	L
C	S	N	C	P	L	A	R	S	R	P
F	Y	A	R	N	O	N	S	O	S	A
L	F	U	H	A	T	E	O	T	O	O
I	X	T	R	S	N	A	N	T	N	C
G	S	A	A	A	T	E	I	P	I	P
H	S	I	N	I	T	X	C	S	C	O
T	B	I	P	L	A	N	E	X	O	A
L	R	I	P	P	L	L	A	F	N	L
A	R	O	R	C	G	L	C	F	E	G
F	L	Y	I	N	G	S	E	I	E	T
C	T	T	N	L	Y	S	Y	U	G	L



KEY:

A	E	A	H	T	R	T	I	E	S	R
G	L	S	E	E	R	I	H	S	S	O
I	I	T	N	L	O	X	Y	L	U	E
I	F	R	E	T	P	P	P	X	P	X
P	T	O	A	P	I	L	E	H	E	L
C	S	N	C	P	L	A	R	S	R	P
F	Y	A	R	N	O	N	S	O	S	A
L	F	U	H	A	T	E	O	T	O	O
I	X	T	R	S	N	A	N	T	N	C
G	S	A	A	A	T	E	I	P	I	P
H	S	I	N	I	T	X	C	S	C	O
T	B	I	P	L	A	N	E	X	O	A
L	R	I	P	P	L	L	A	F	N	L
A	R	O	R	C	G	L	C	F	E	G
F	L	Y	I	N	G	S	E	I	E	T
C	T	T	N	L	Y	S	Y	U	G	L

